



密码挂锁/Combination Padlock ..... 04/17



柜锁/Cabinet Lock ..... 18/20



固定锁/Fixed Lock ..... 21/22



电脑锁/Computer Lock ..... 23/24



海关锁/TSA Lock ..... 25/26



指纹锁/Smart Lock ..... 27

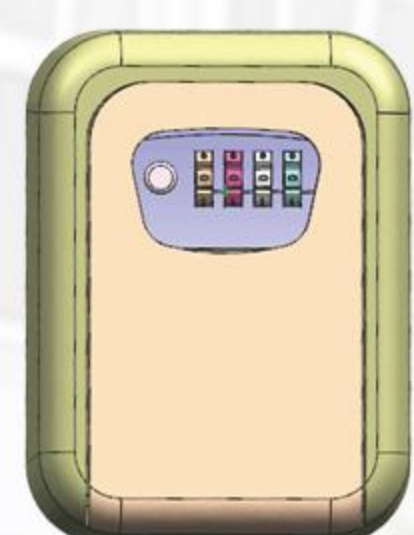

盒锁/Key Box Lock ..... 28



钥匙锁/Key Lock ..... 29/32



自行车锁/Bicycle Lock ..... 33

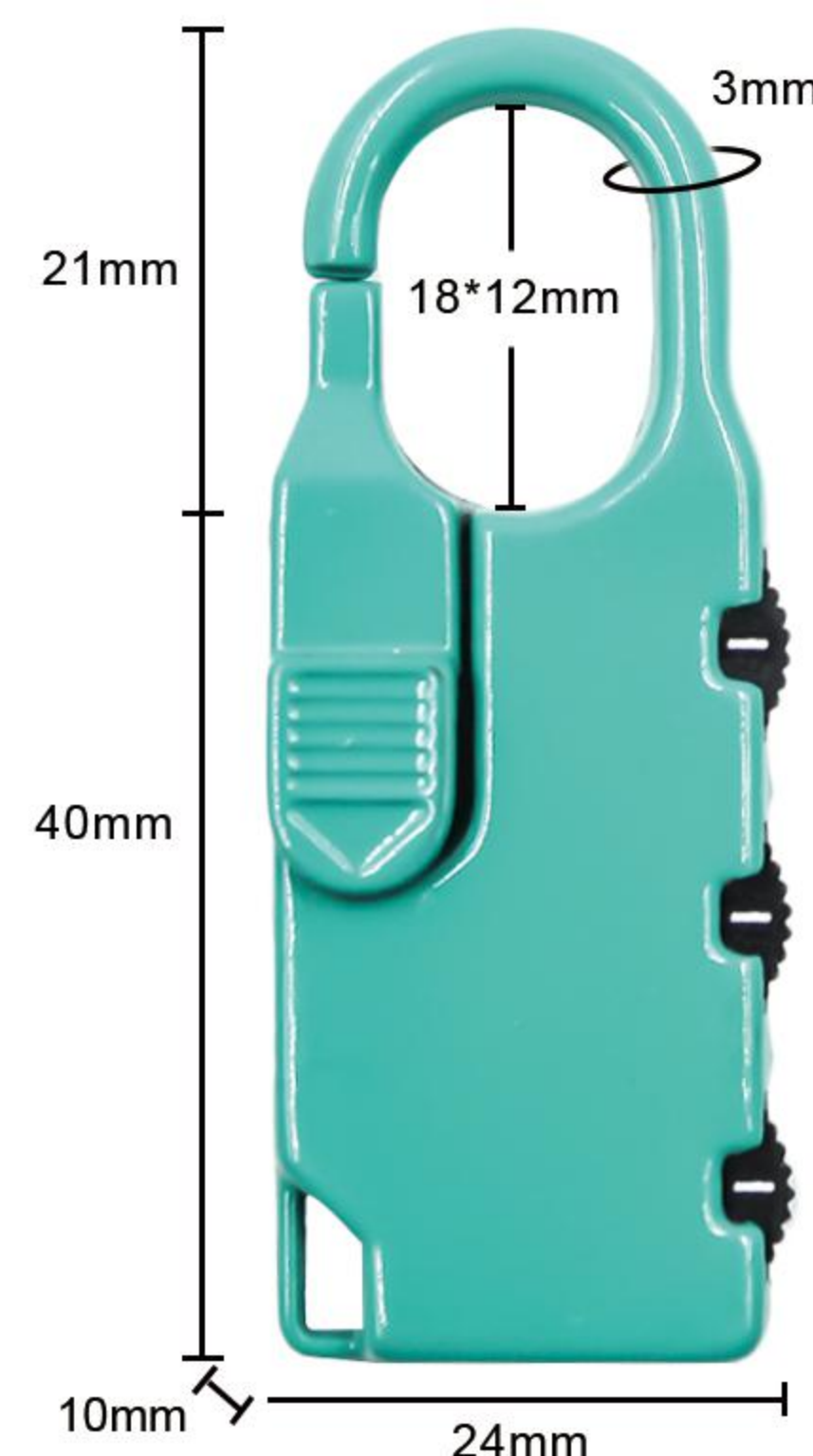

**Item:8001**

Size: 2.40\*0.94\*0.39in

Material: Zinc alloy

Weight: 17.5g

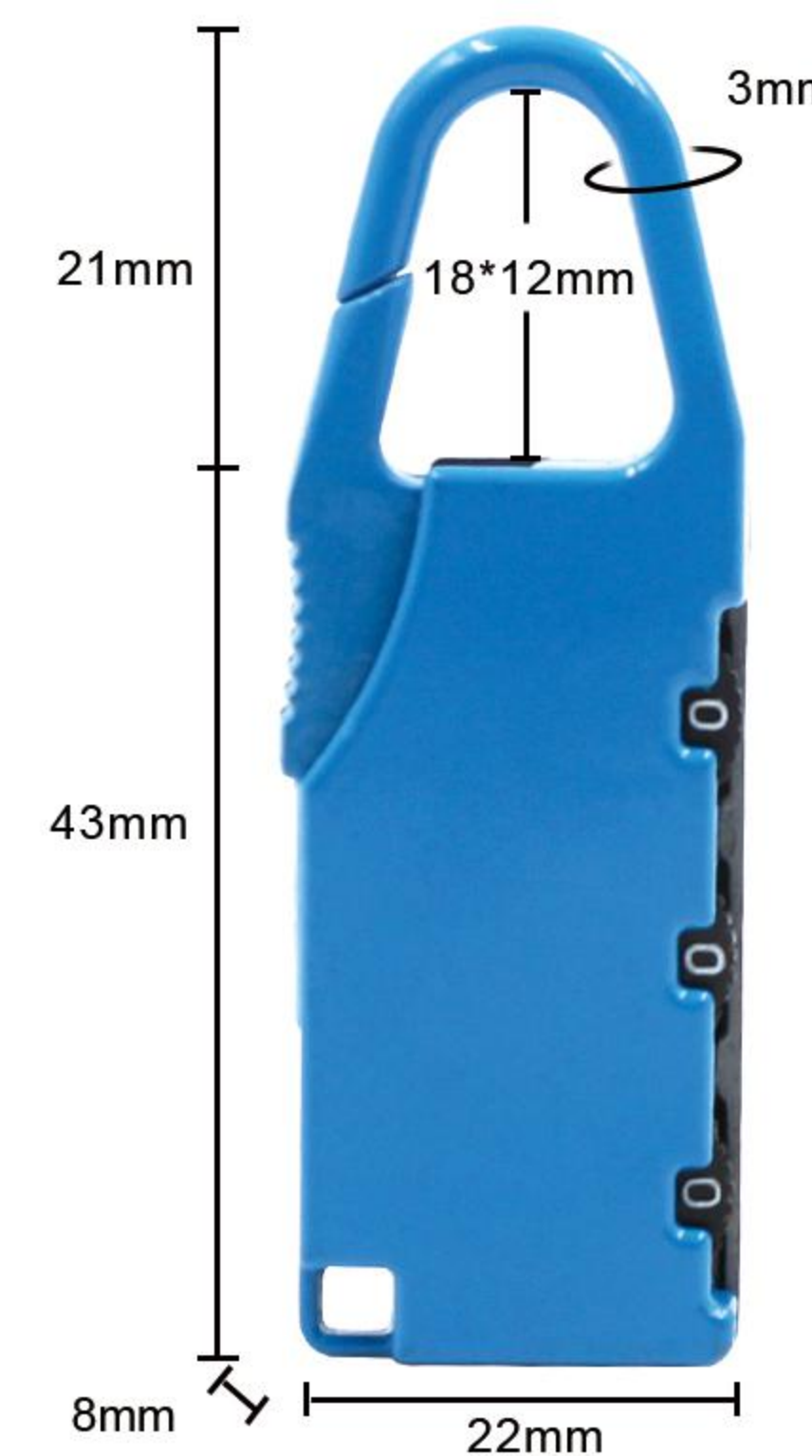

**Item:8002**

Size: 2.52\*0.87\*0.31in

Material: Zinc alloy

Weight: 18g



**Item:8003**

Size: 2.20\*0.83\*0.47in

Material: Zinc alloy

Weight: 15g

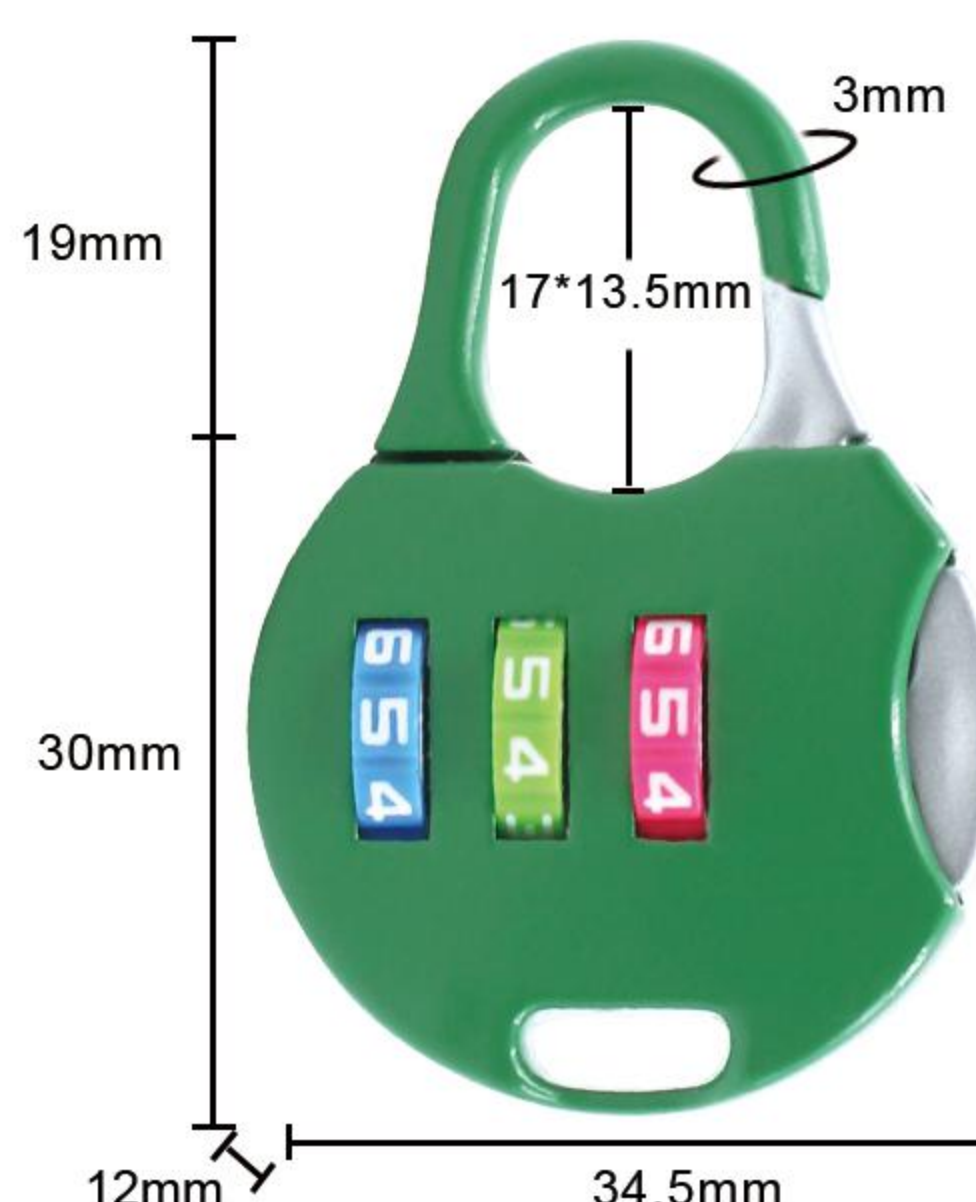

**Item:8004**

Size: 1.92\*1.36\*0.47in

Material: Zinc alloy

Weight: 17.8g

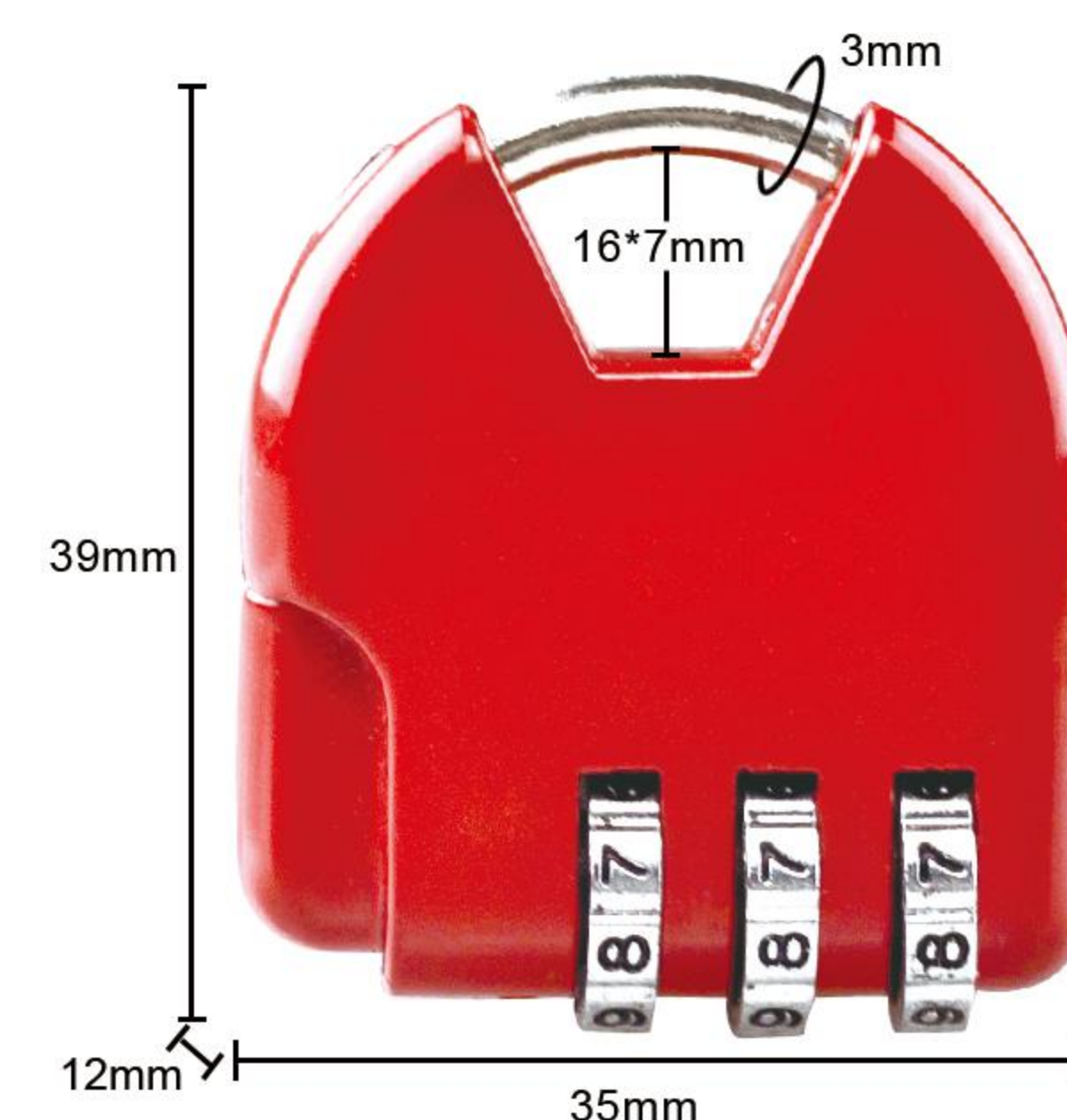

**Item:8005**

Size: 1.54\*1.38\*0.47in

Material: Zinc alloy

Weight: 20.4g



**Item:8006**

Size: 2.32\*0.87\*0.47in

Material: Zinc alloy

Weight: 21.4g



**Item:8006A**

Size: 2.32\*0.83\*0.47in

Material: Zinc alloy

Weight: 22.2g

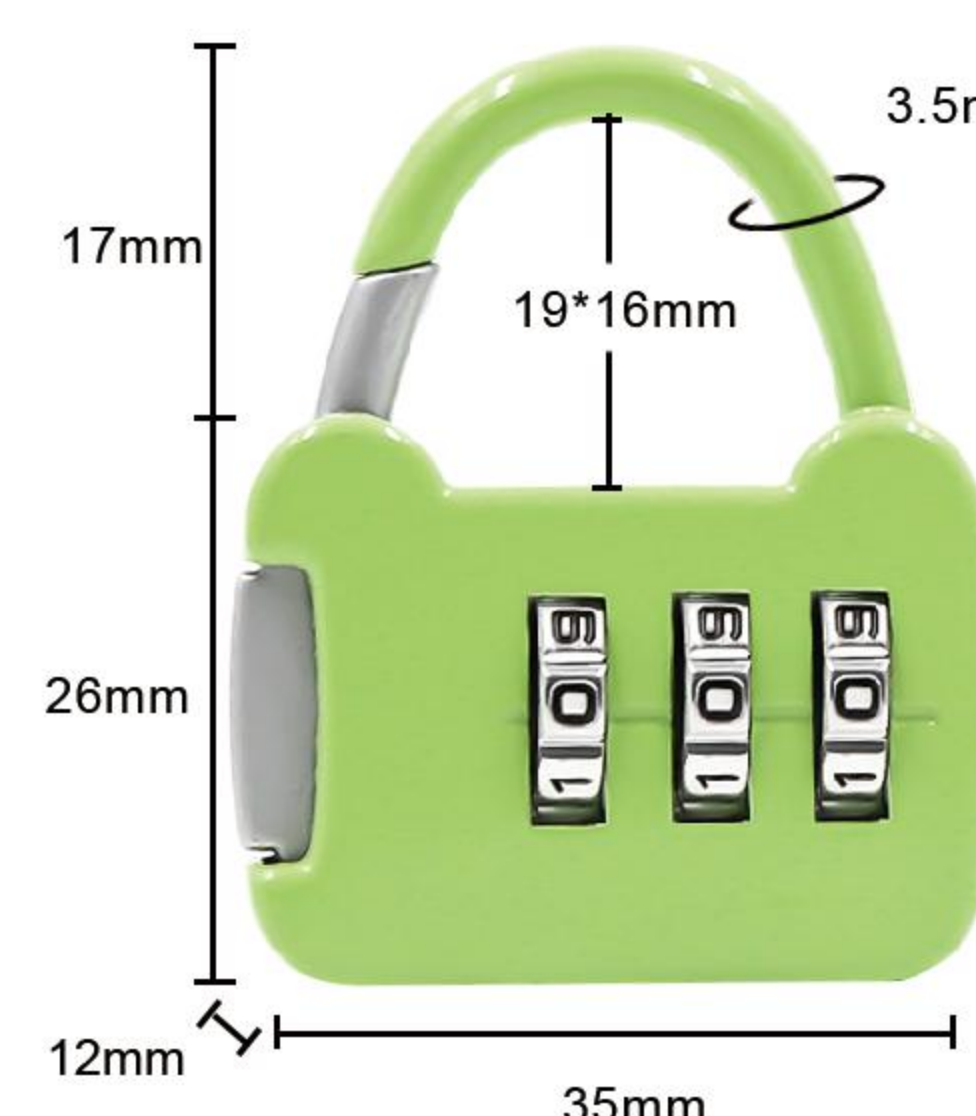

**Item:8007**

Size: 1.69\*1.37\*0.47in

Material: Zinc alloy

Weight: 15g

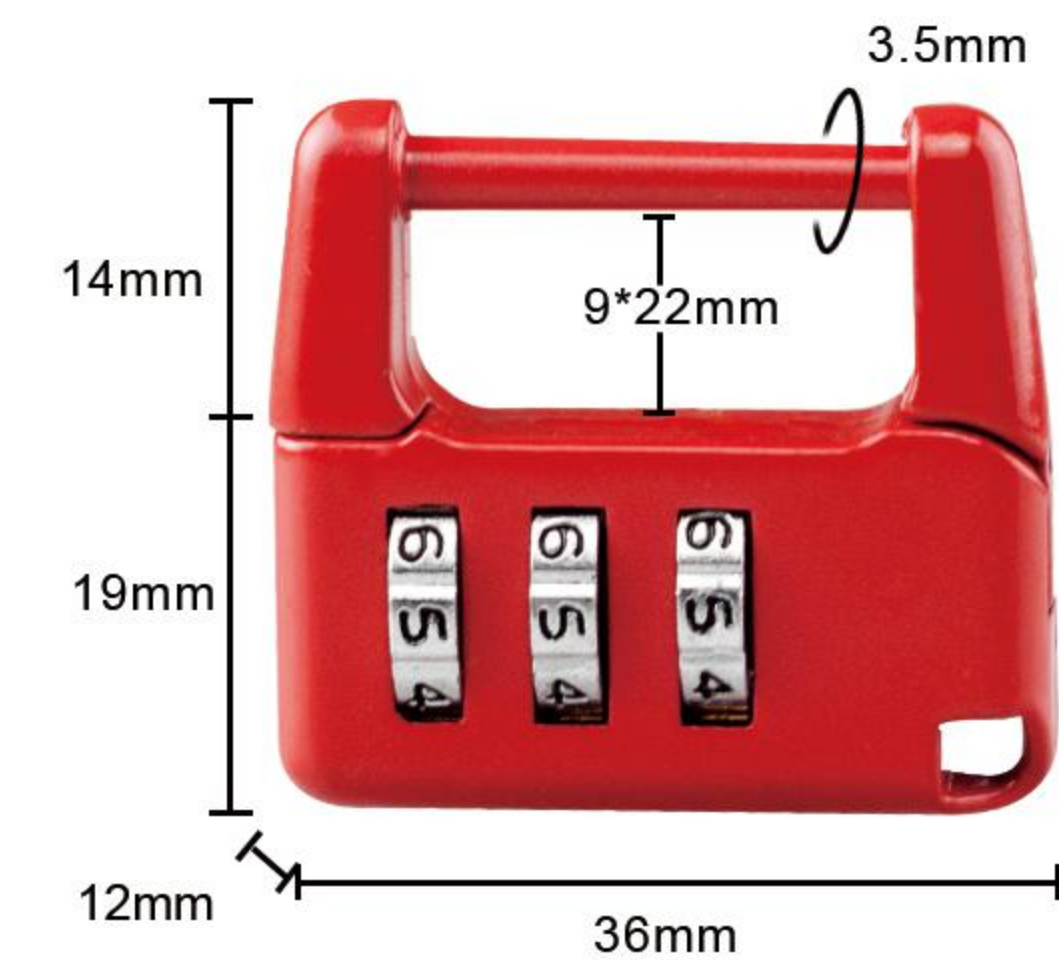

**Item:8008**  
Size: 1.30\*1.42\*0.47in  
Material: Zinc alloy  
Weight: 19.5g

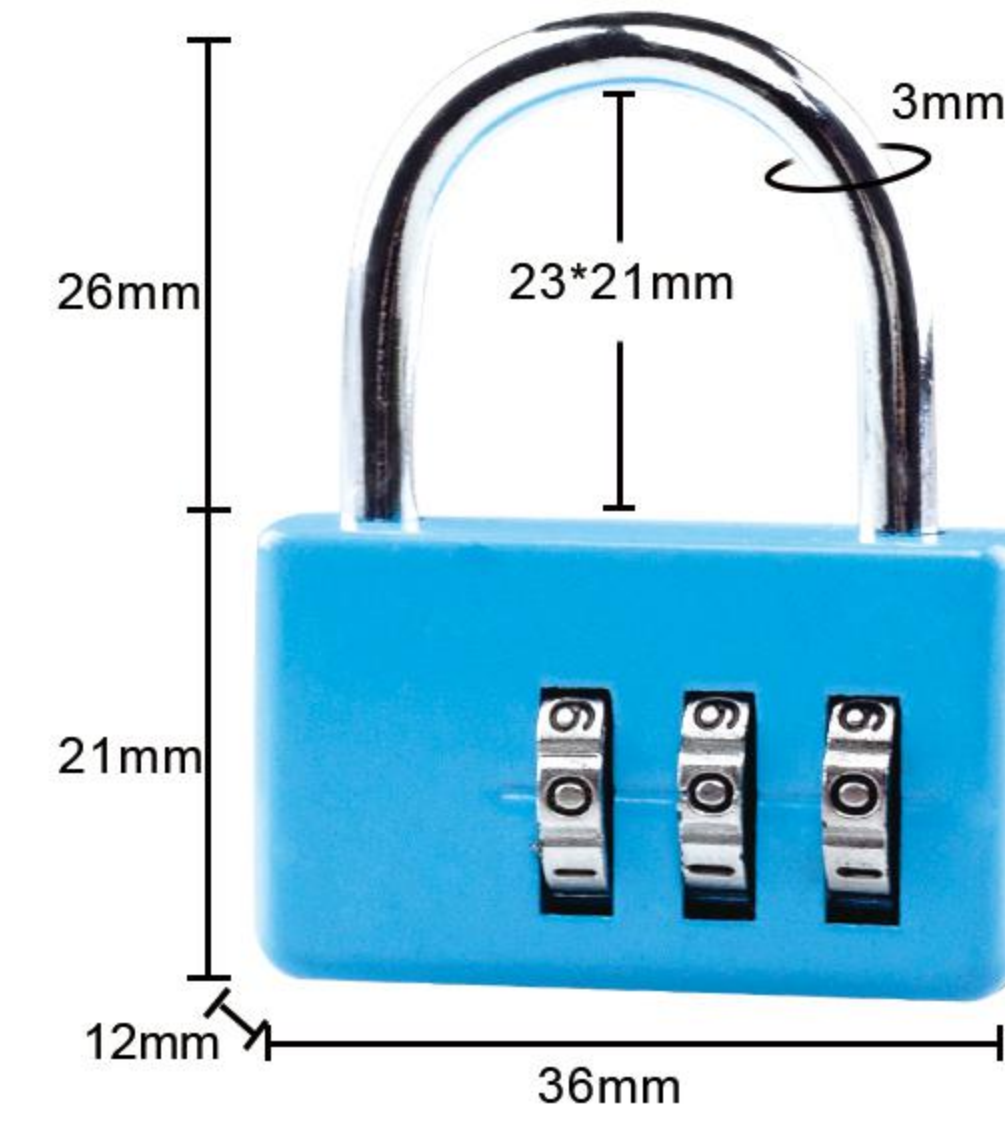

**Item:8009**  
Size: 1.73\*1.42\*0.47in  
Material: Zinc alloy  
Weight: 24g

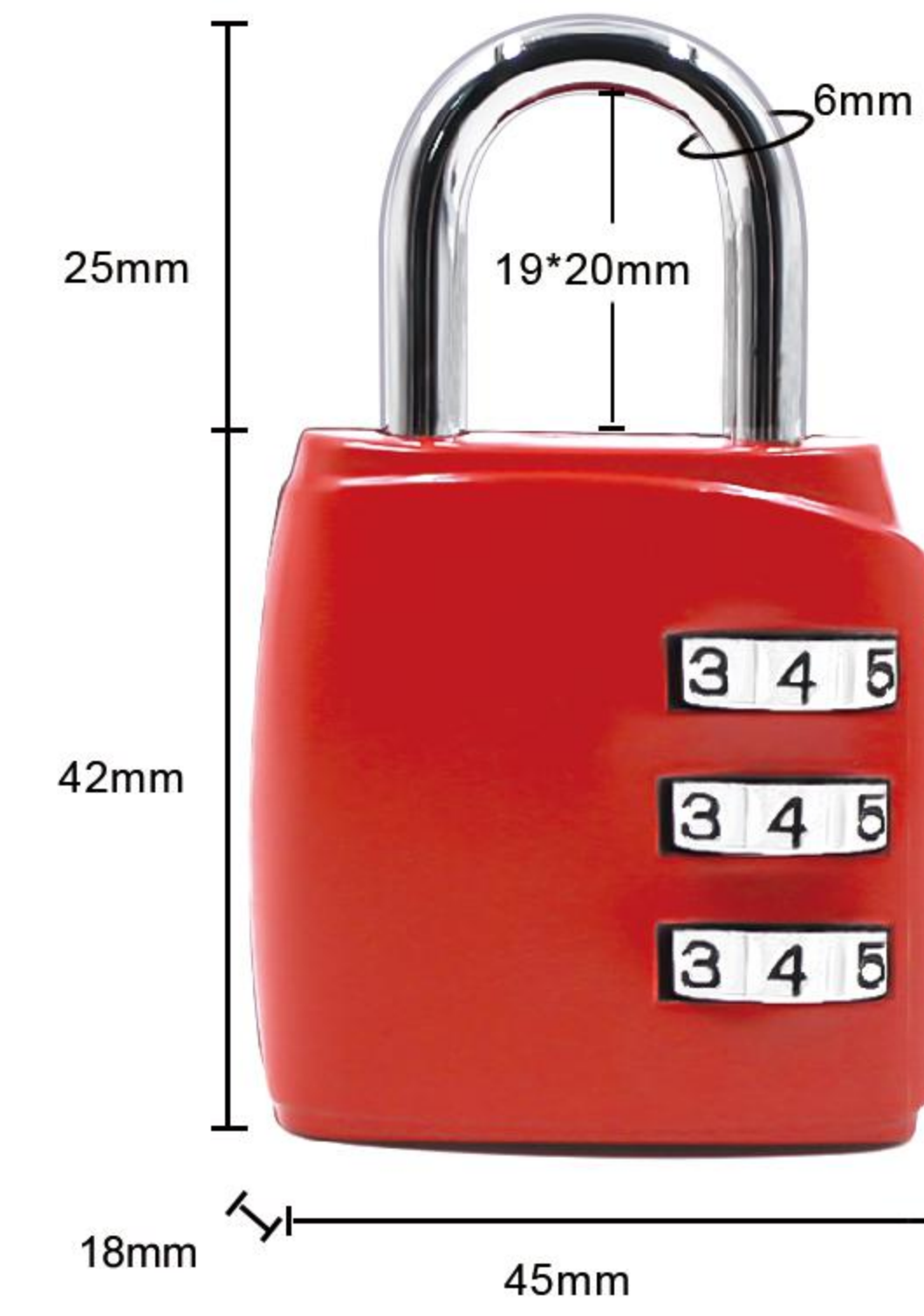

**Item:8016A**  
Size: 2.63\*1.77\*0.71in  
Material: Zinc alloy  
Weight: 122.5g

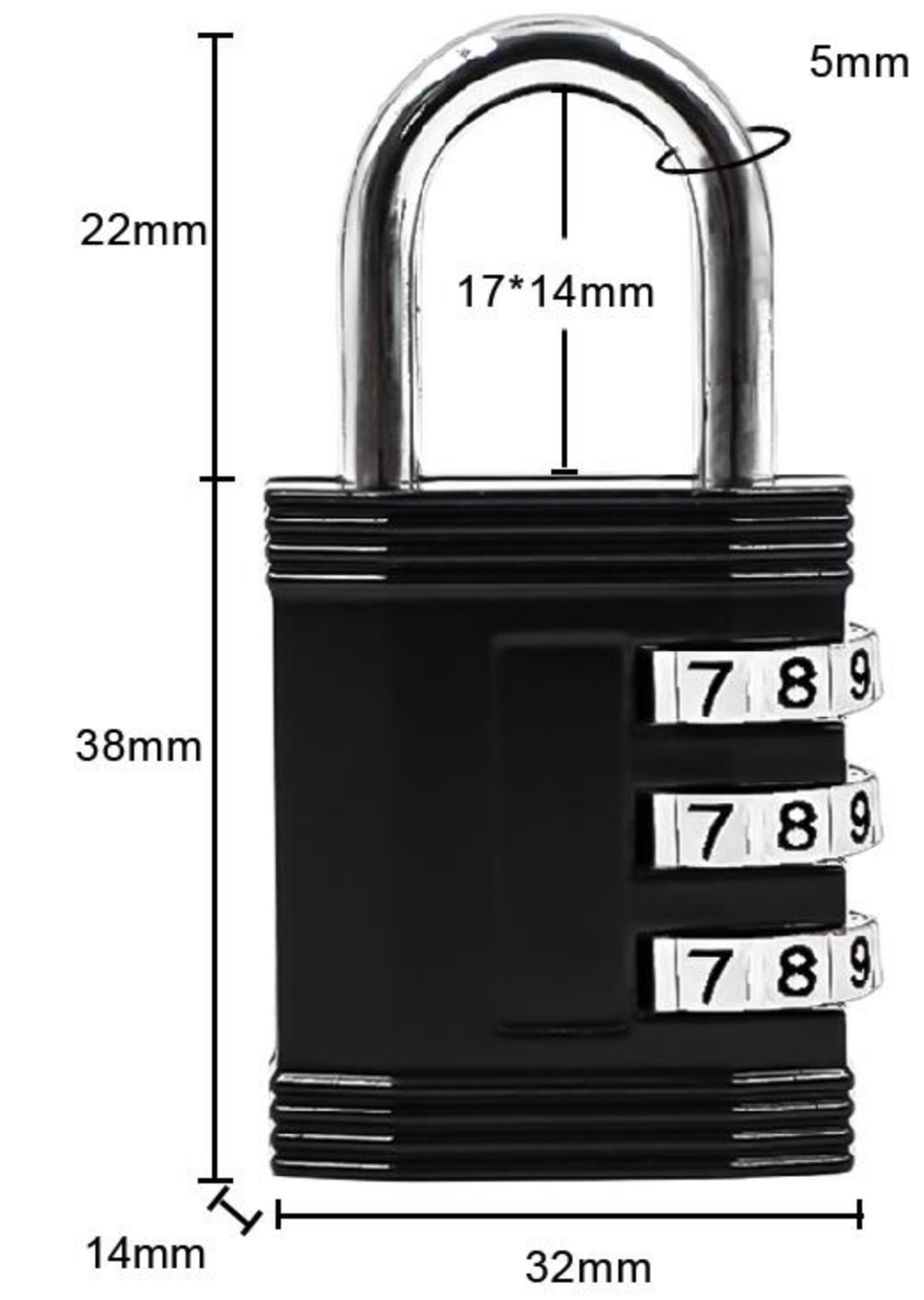

**Item:8017**  
Size: 2.36\*1.26\*0.55in  
Material: Zinc alloy  
Weight: 60.2g

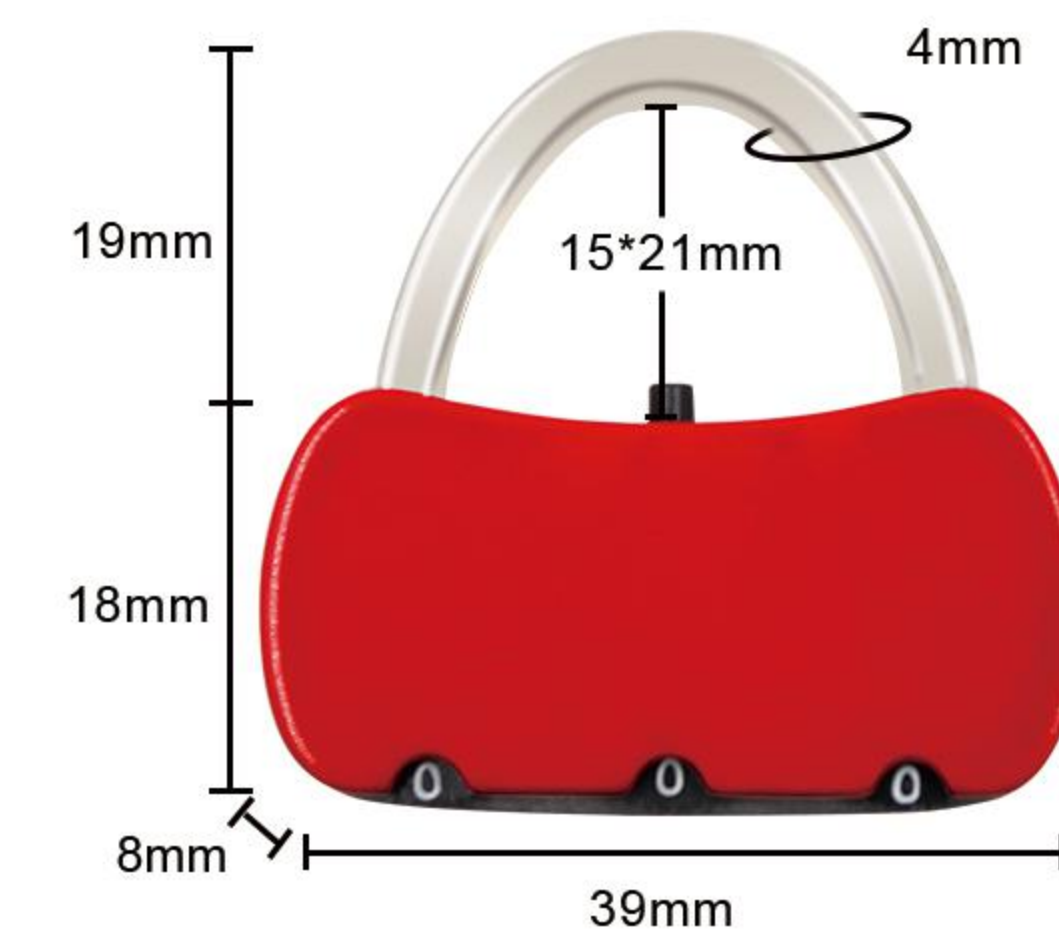

**Item:8010**  
Size: 1.41\*1.53\*0.35in  
Material: Zinc alloy  
Weight: 20.9g

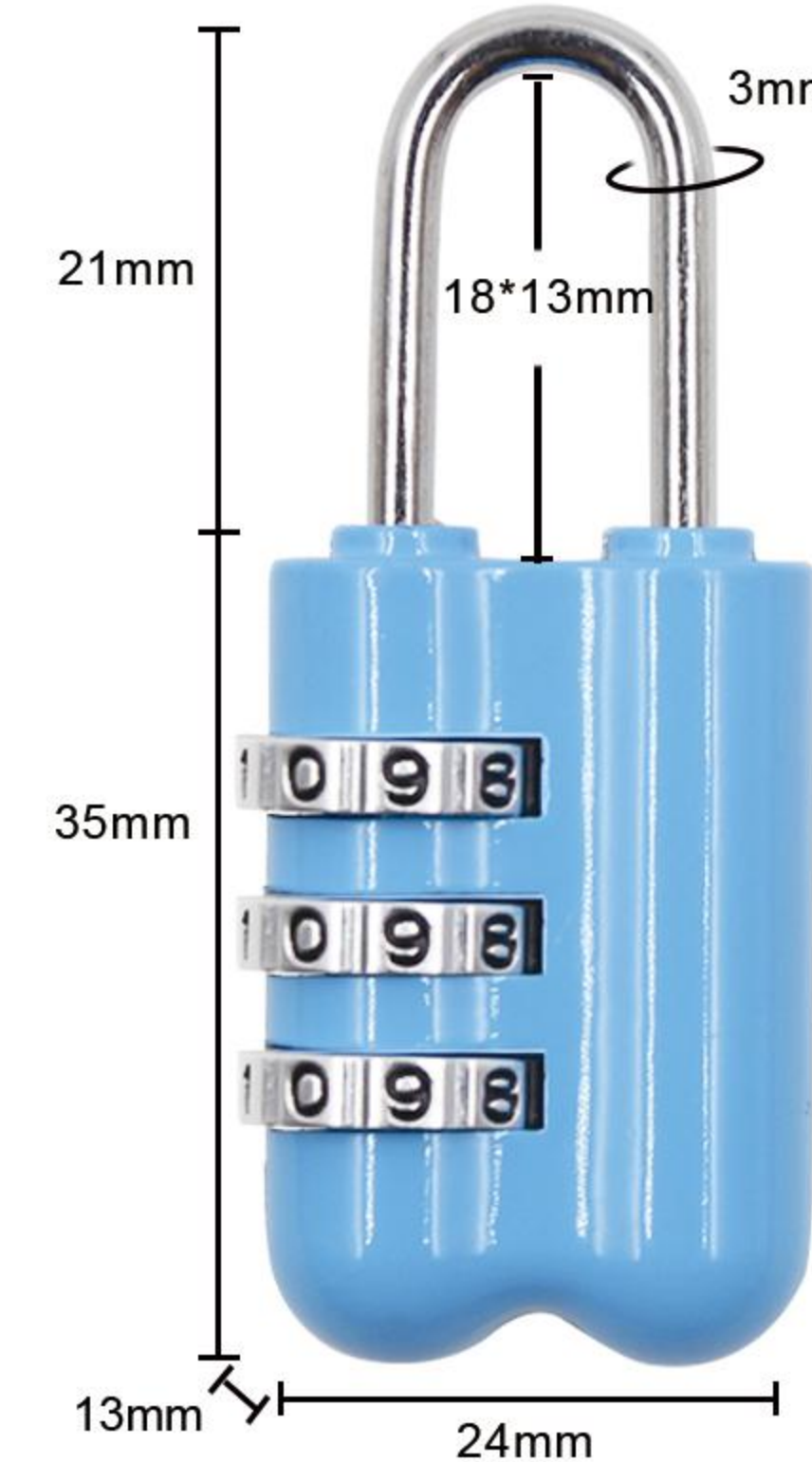

**Item:8011**  
Size: 2.20\*0.94\*0.51in  
Material: Zinc alloy  
Weight: 21.7g

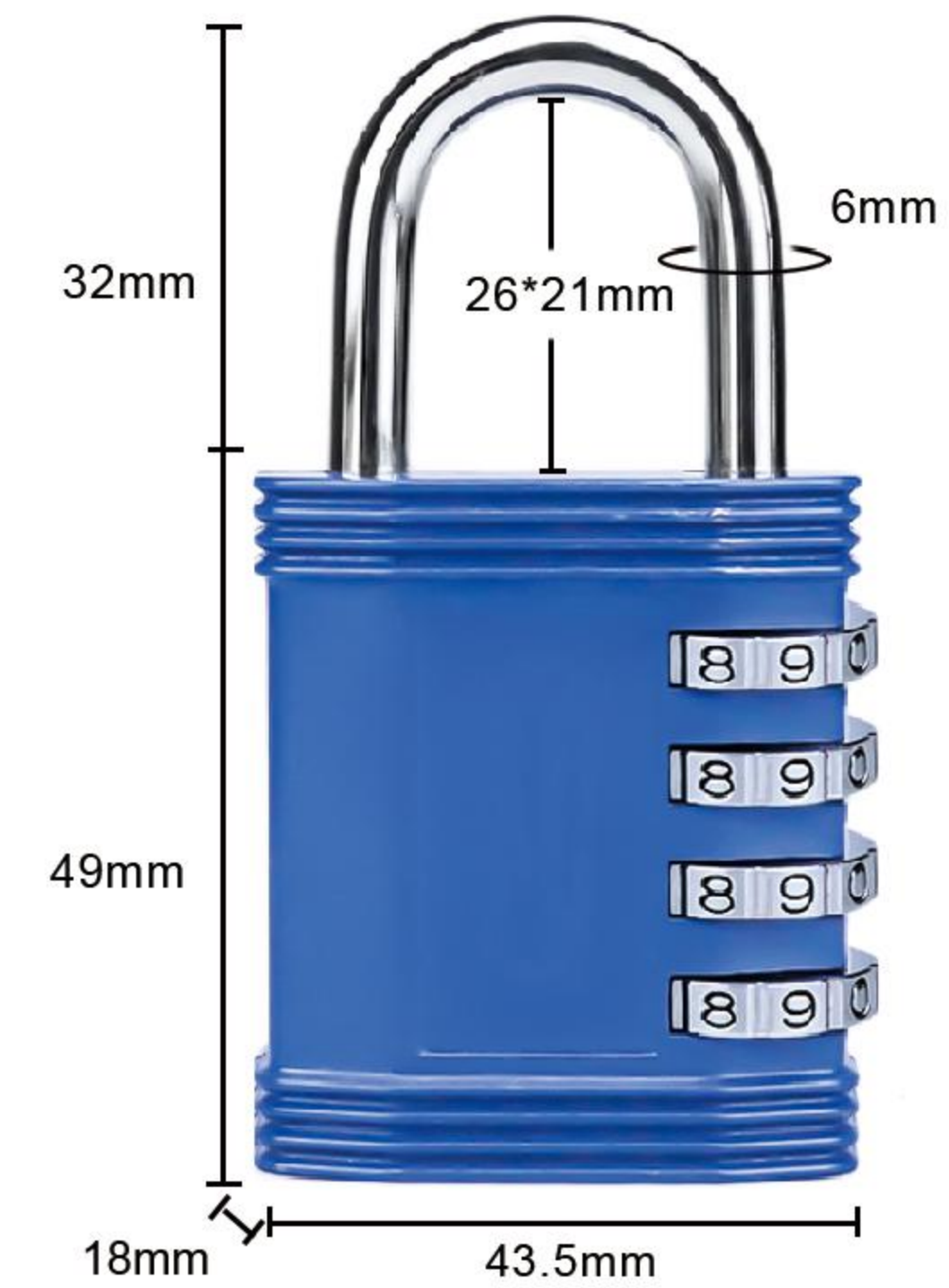

**Item:8017A**  
Size: 3.19\*1.71\*0.71in  
Material: Zinc alloy  
Weight: 129.4g



**Item:8018**  
Size: 2.20\*0.98\*0.47in  
Material: Zinc alloy  
Weight: 16.8g

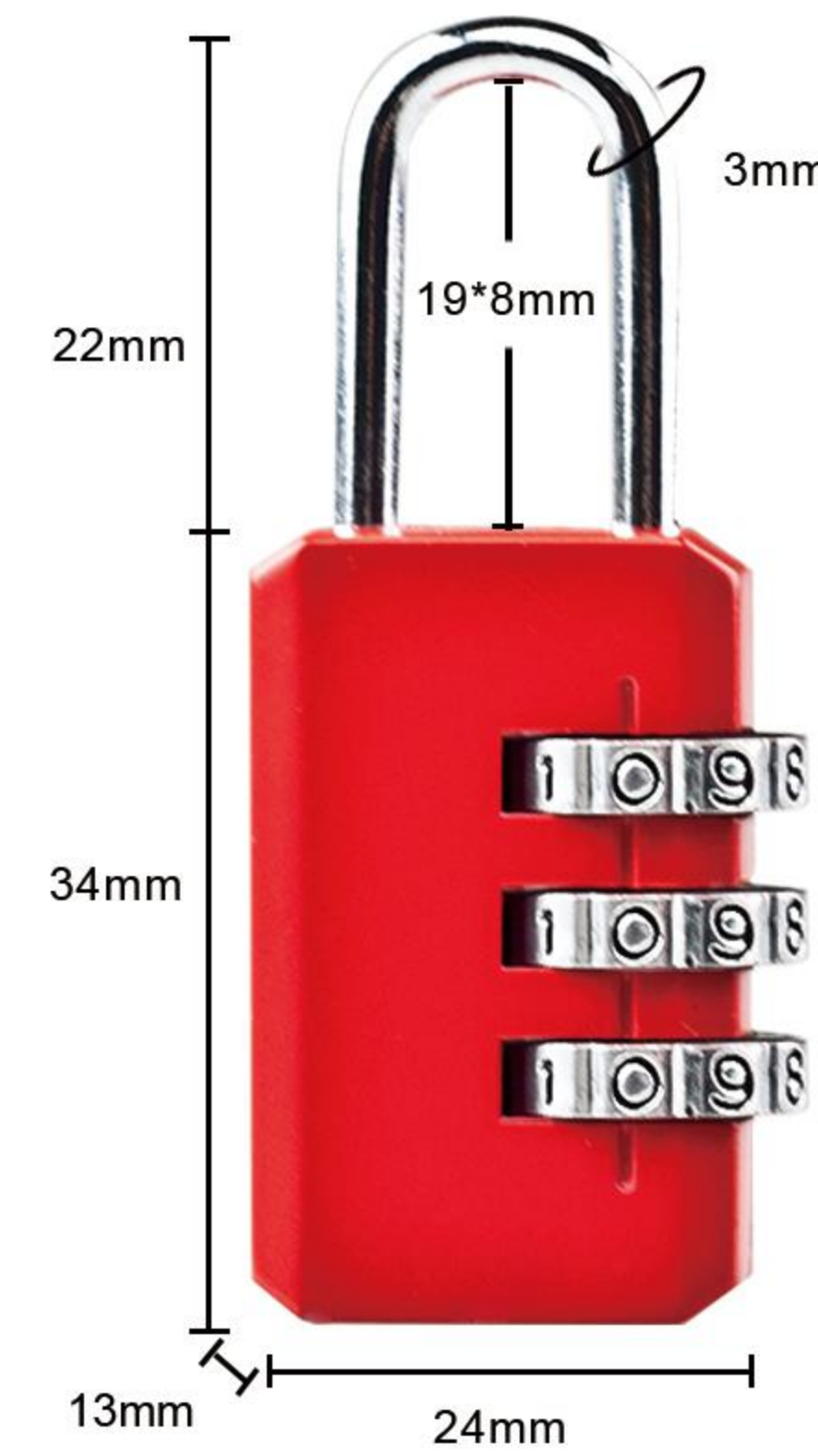

**Item:8012**  
Size: 2.20\*0.94\*0.51in  
Material: Zinc alloy  
Weight: 22.8g

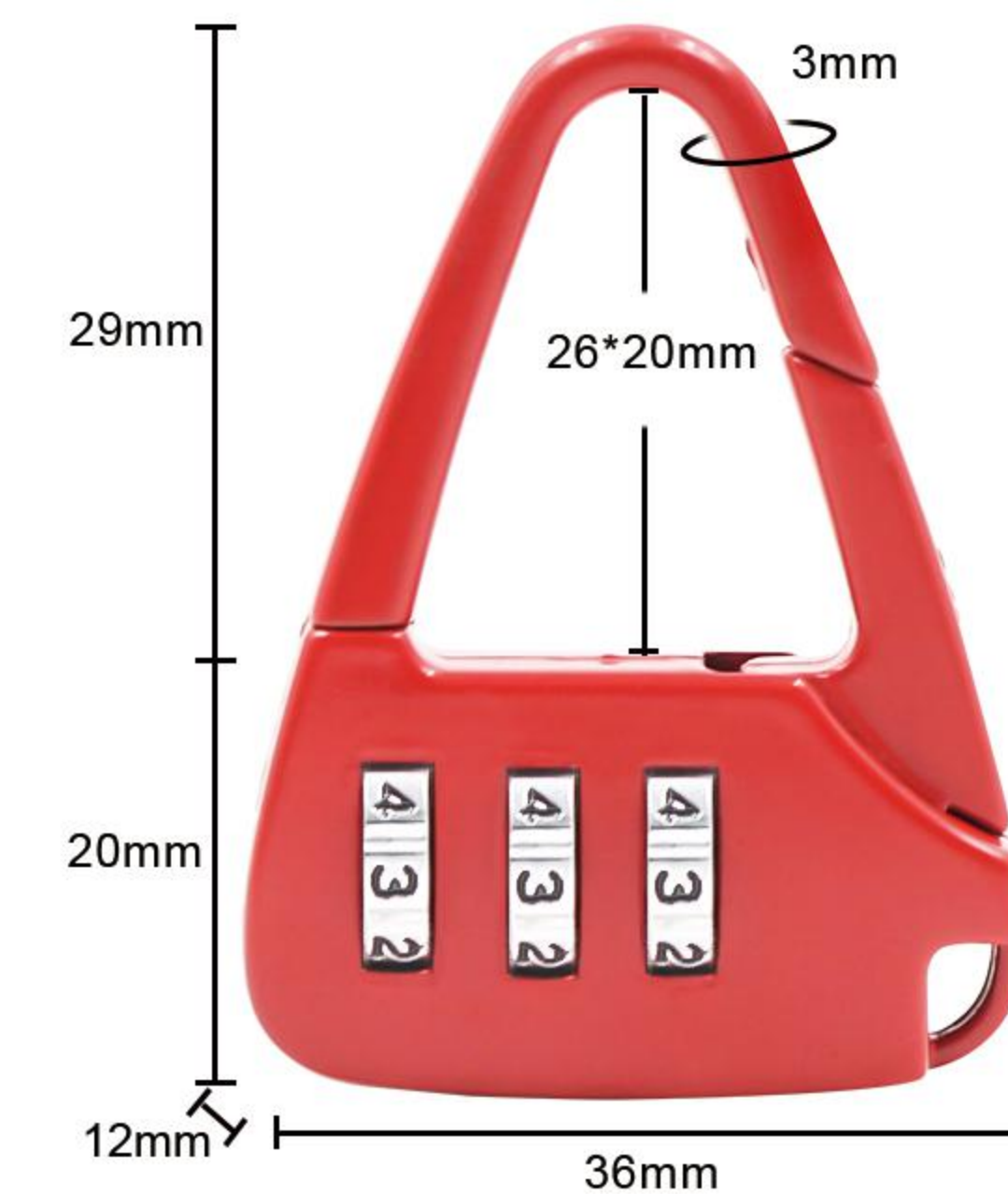

**Item:8013**  
Size: 1.93\*1.41\*0.47in  
Material: Zinc alloy  
Weight: 23.2g

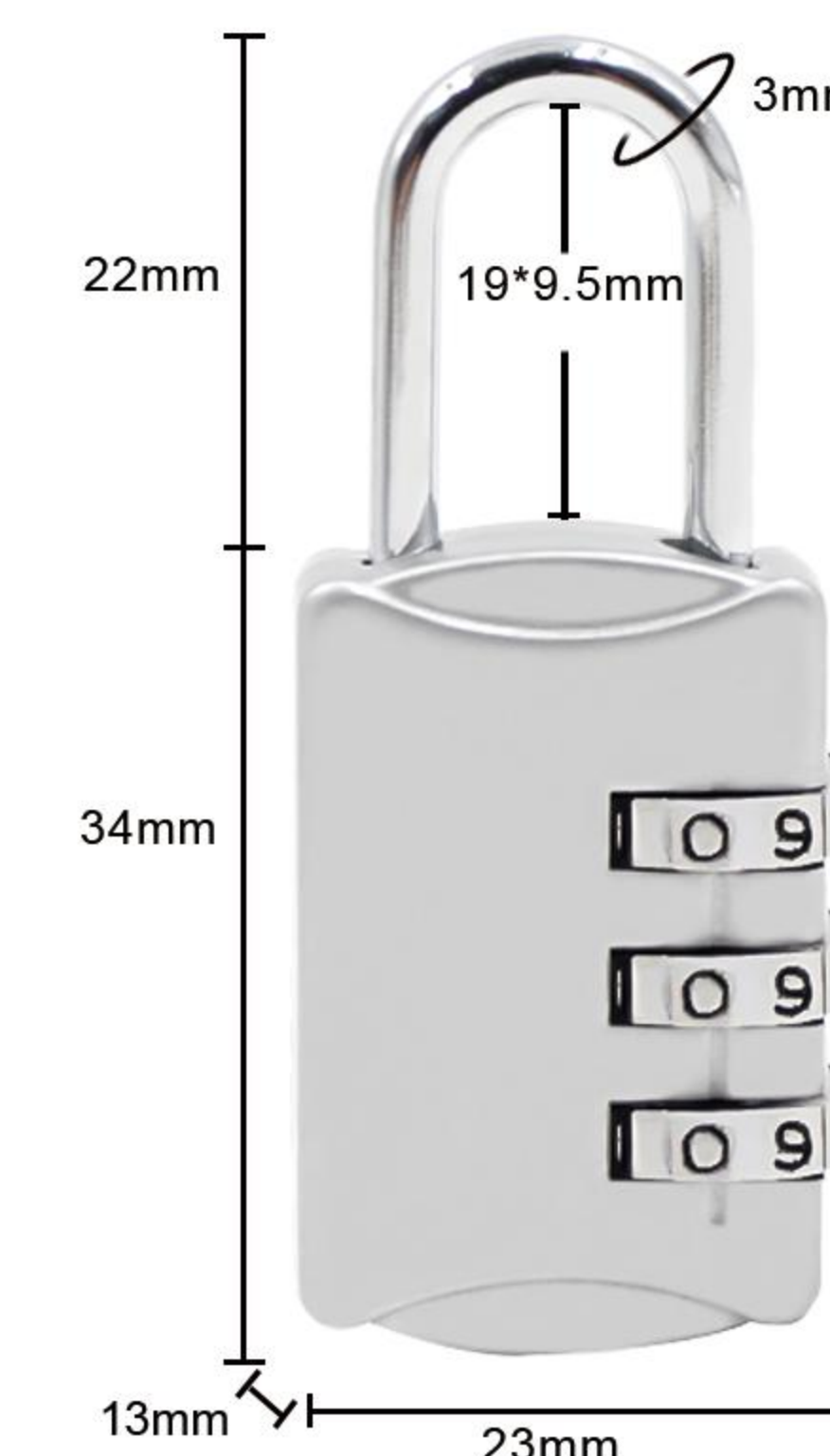

**Item:8019**  
Size: 2.20\*0.90\*0.51in  
Material: Zinc alloy  
Weight: 25.1g

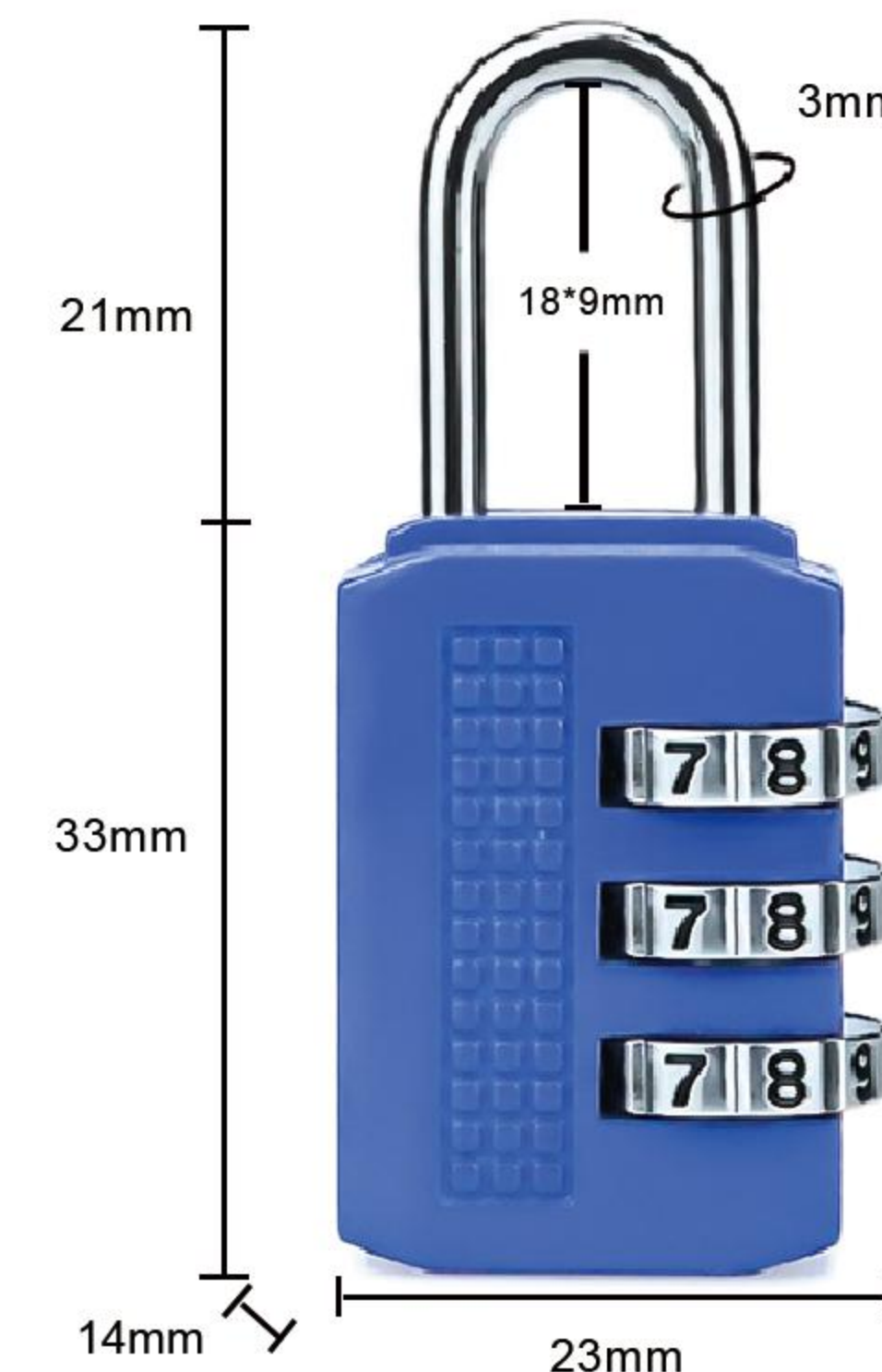

**Item:8020**  
Size: 2.07\*0.90\*0.55in  
Material: Zinc alloy  
Weight: 29.3g

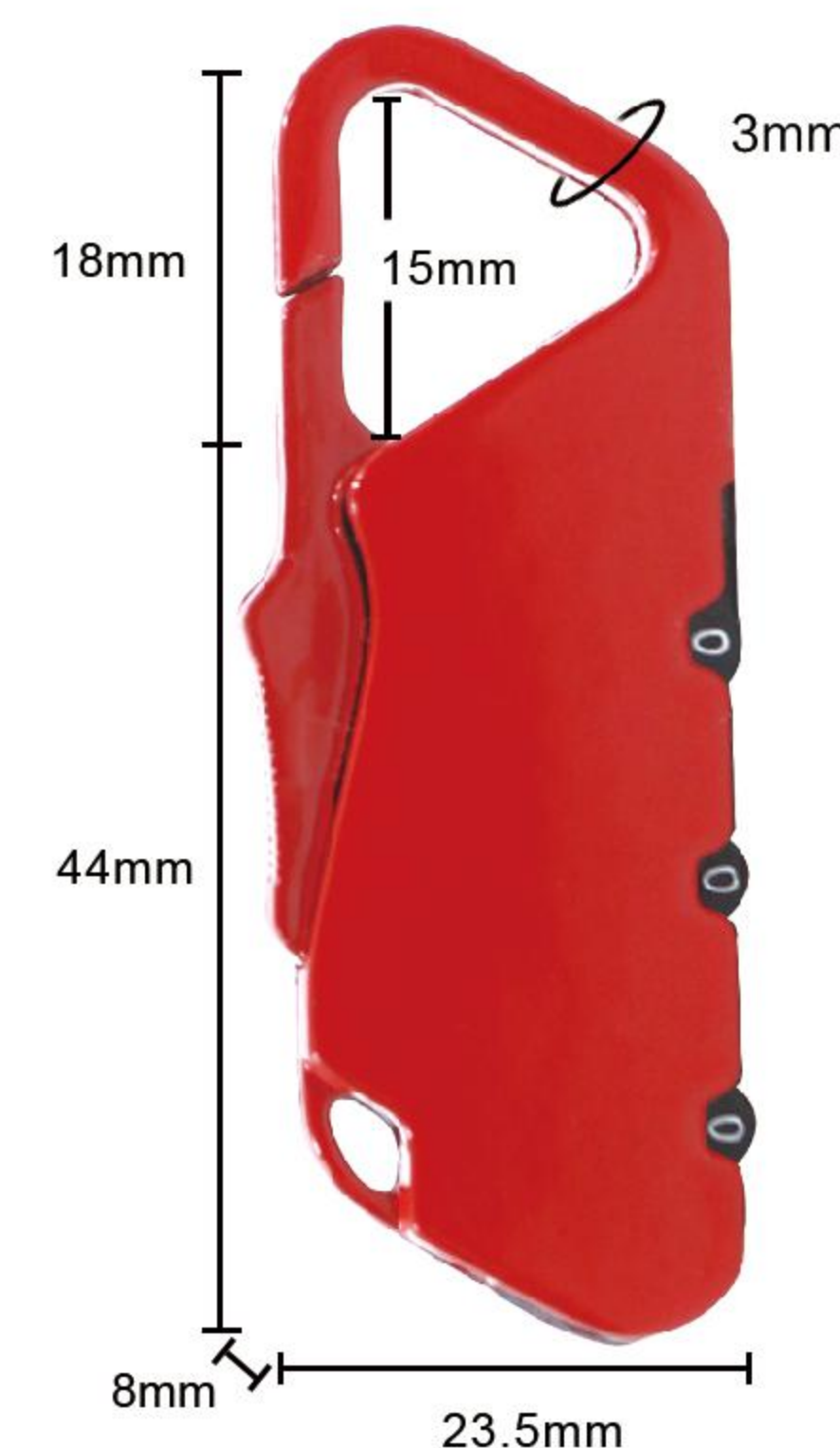

**Item:8015**  
Size: 2.44\*0.92\*0.31in  
Material: Zinc alloy  
Weight: 19.6g

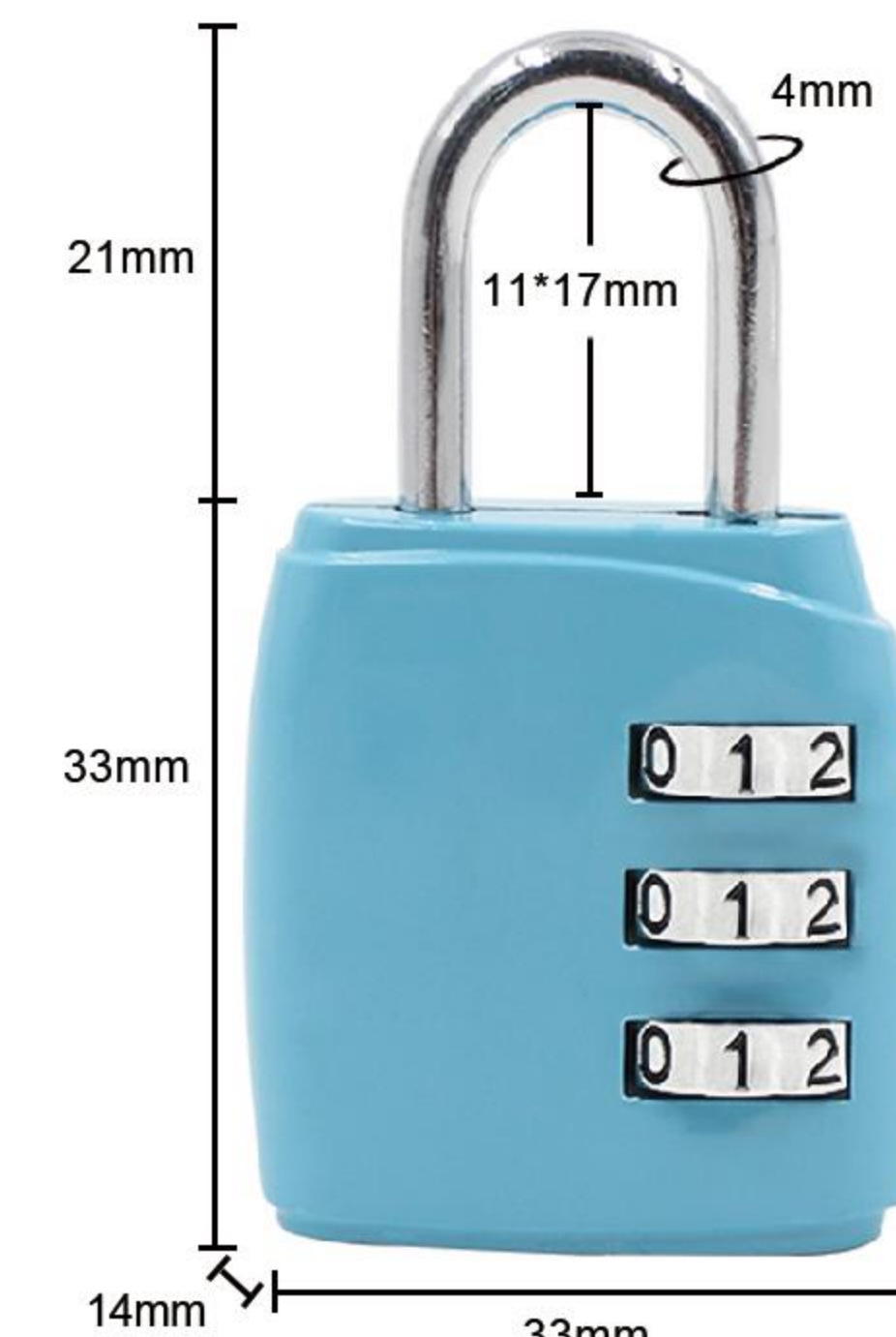

**Item:8016**  
Size: 2.12\*1.30\*0.55in  
Material: Zinc alloy  
Weight: 41.4g

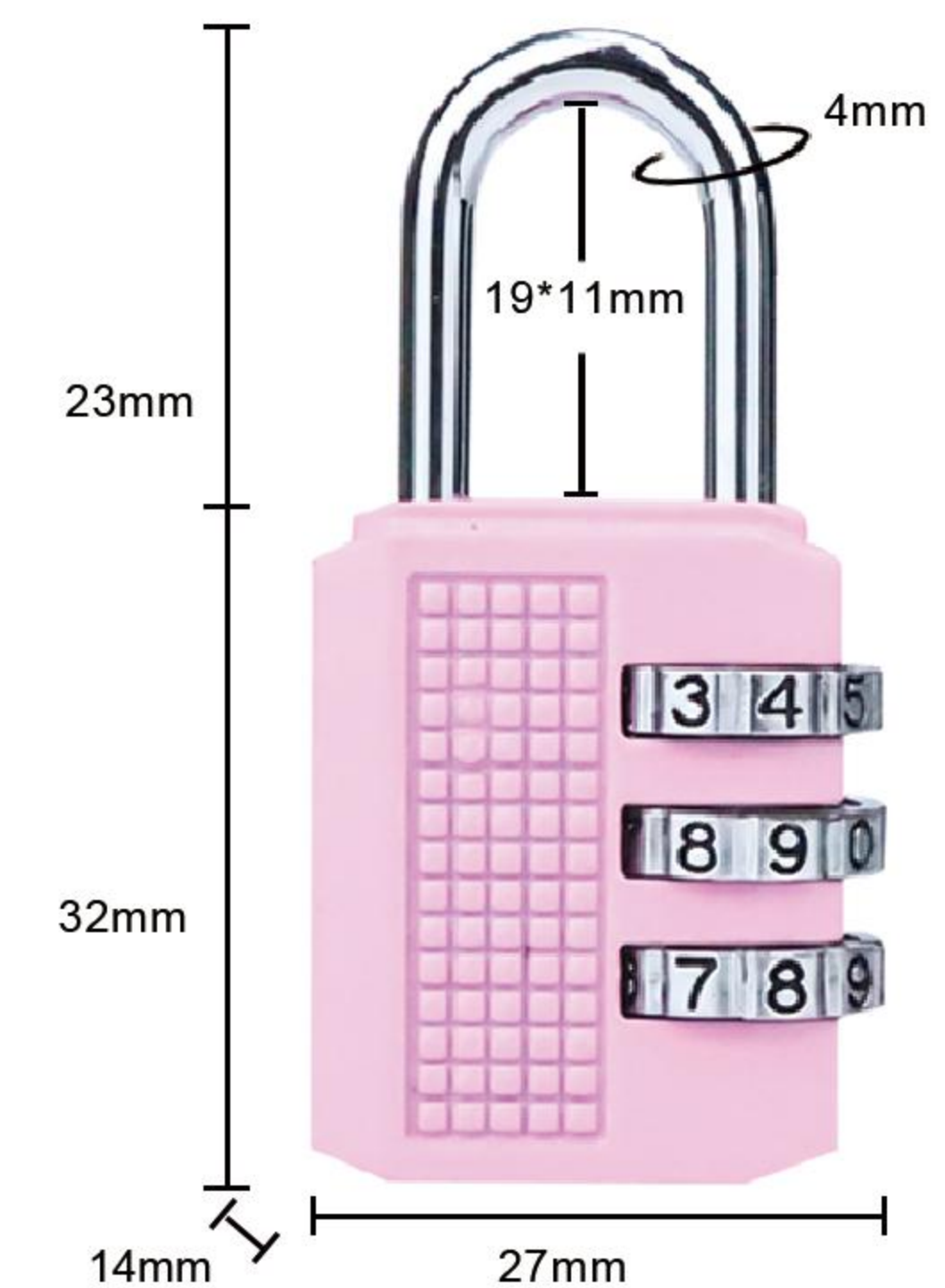

**Item:8021**  
Size: 2.16\*1.06\*0.55in  
Material: Zinc alloy  
Weight: 35.8g

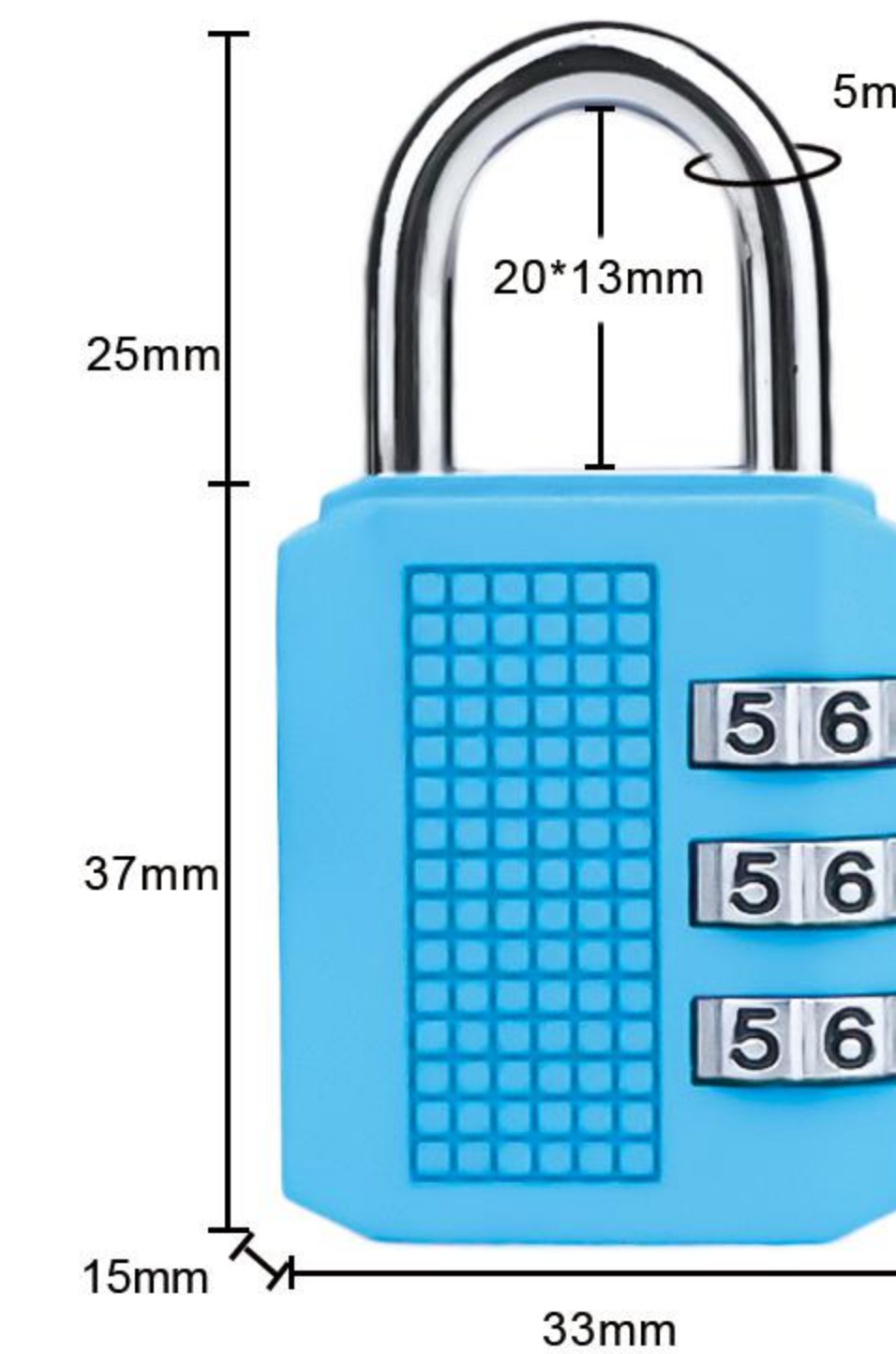

**Item:8022**  
Size: 2.44\*1.30\*0.59in  
Material: Zinc alloy  
Weight: 52.4

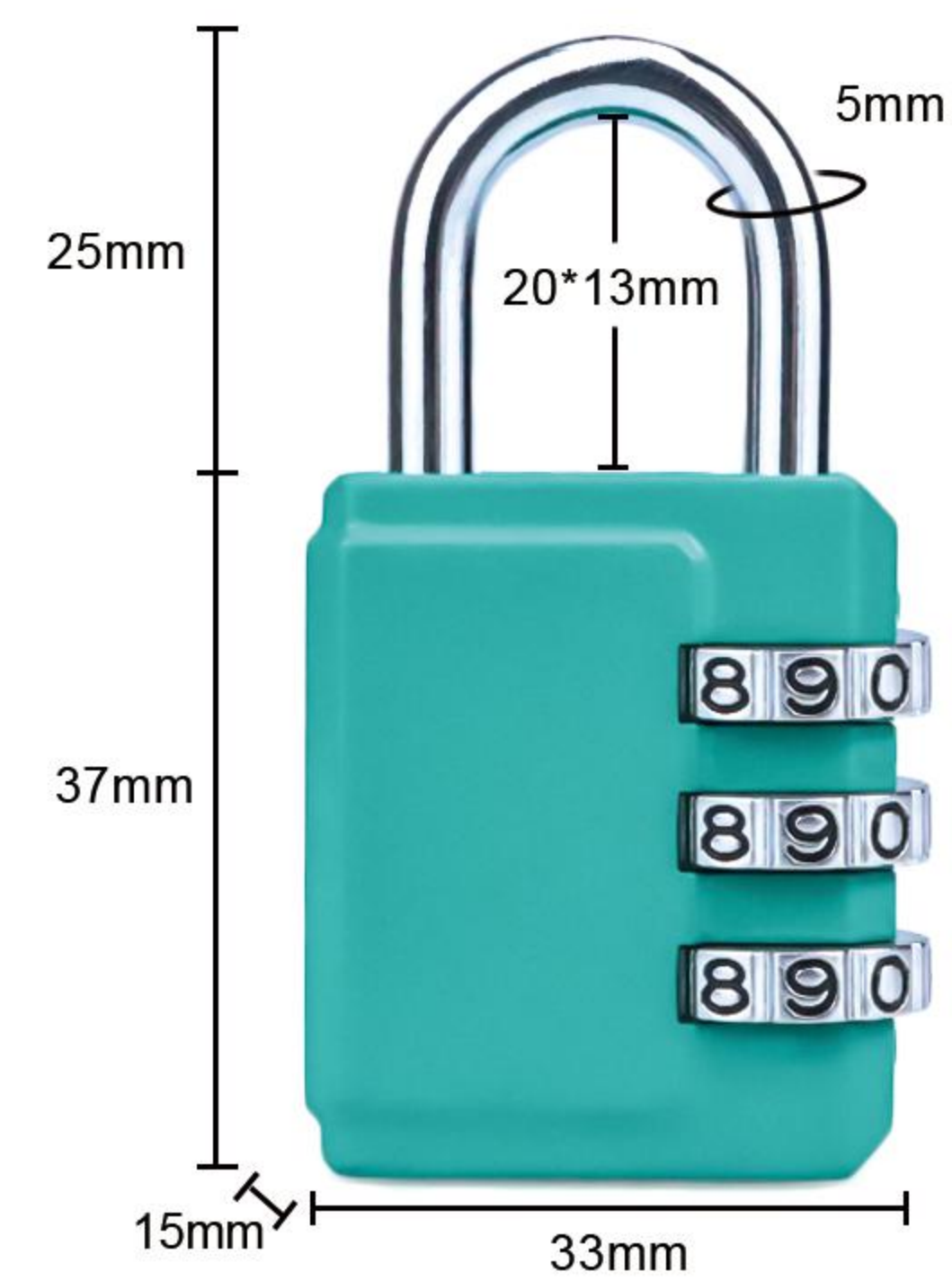

**Item:8022A**  
 Size: 2.44\*1.30\*0.59in  
 Material: Zinc alloy  
 Weight: 58g

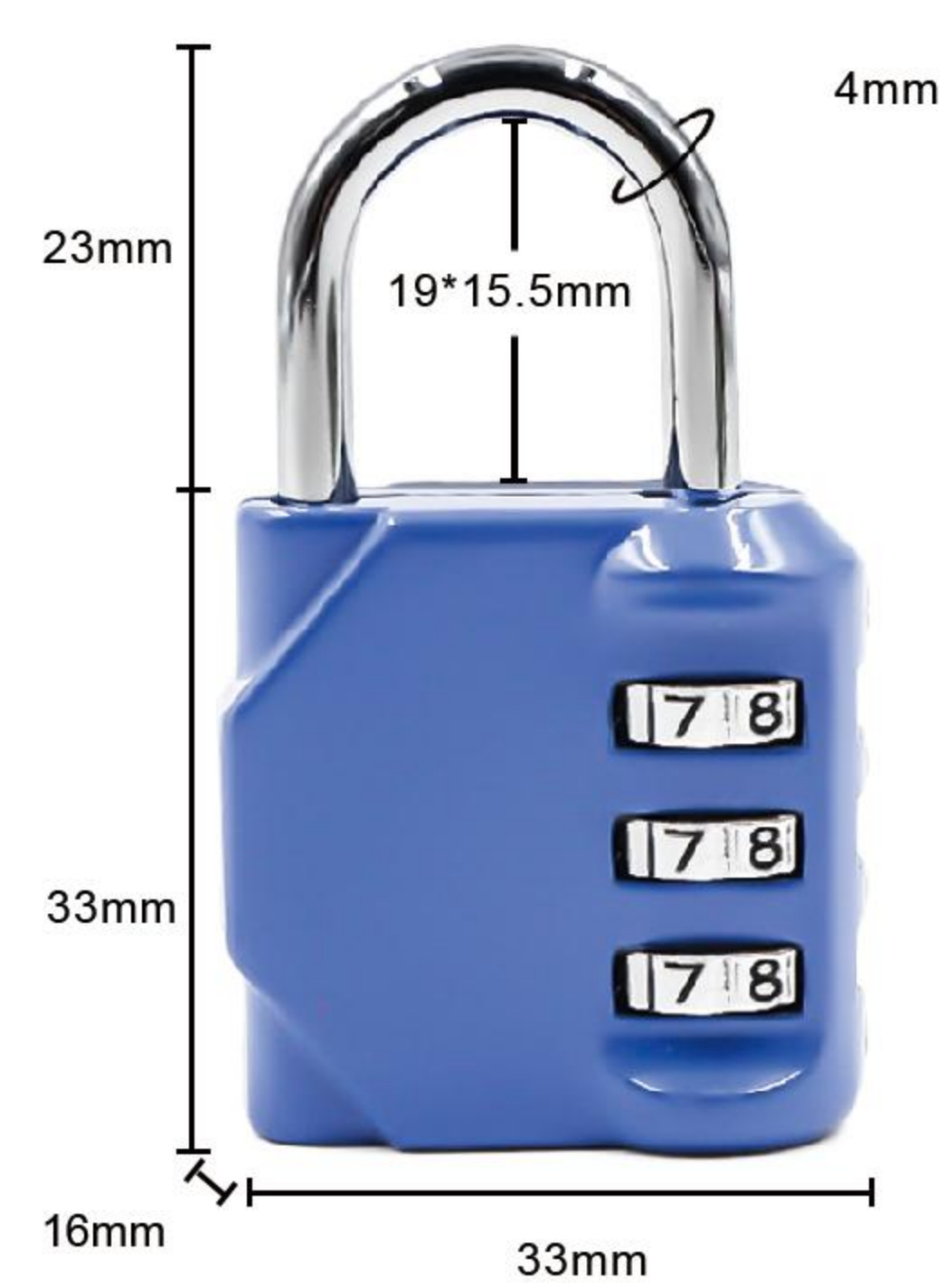

**Item:8023S**  
 Size: 2.20\*1.30\*0.63in  
 Material: Zinc alloy  
 Weight: 44g

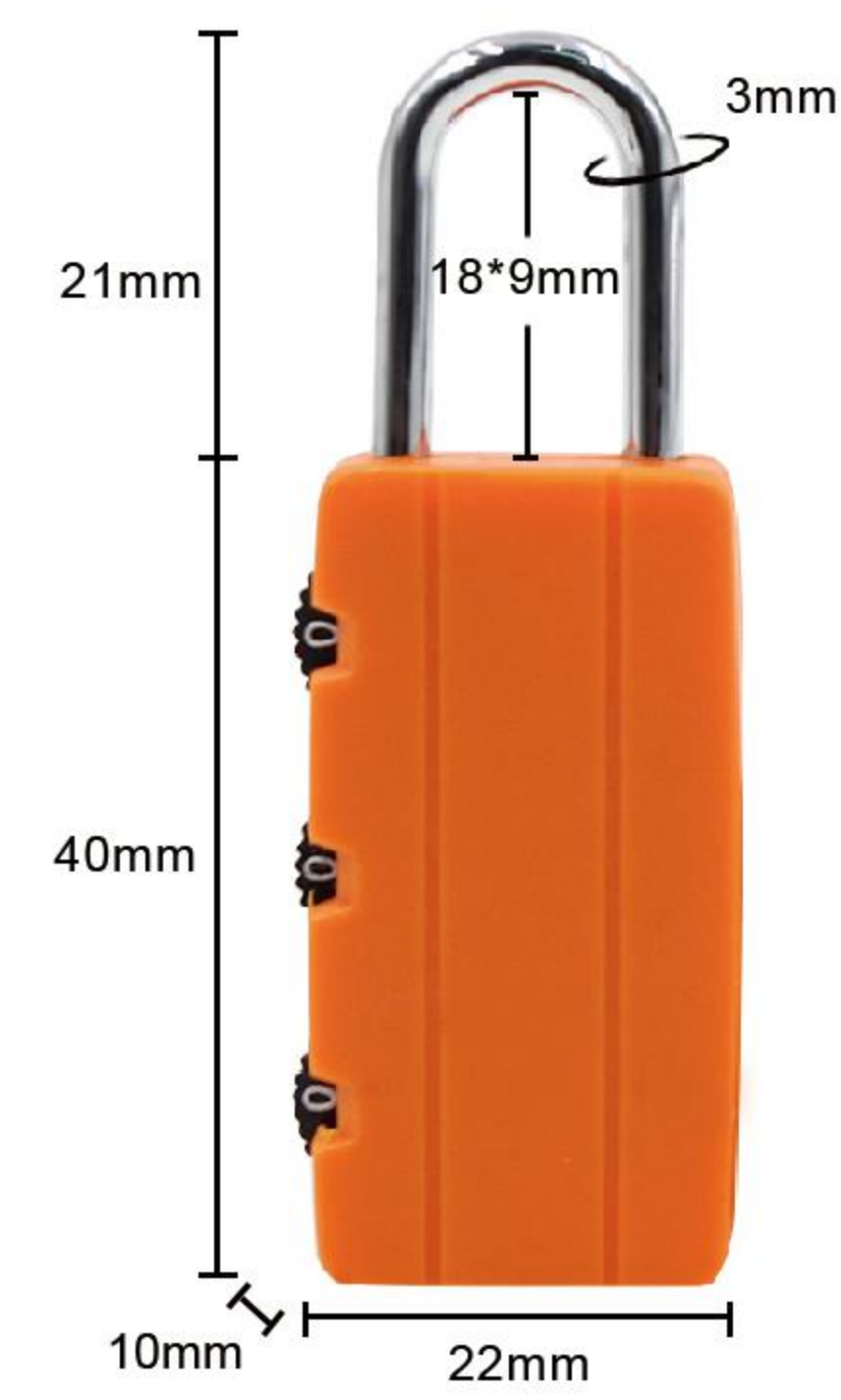

**Item:8027**  
 Size: 2.40\*0.87\*0.39in  
 Material: ABS plastic  
 Weight: 9g

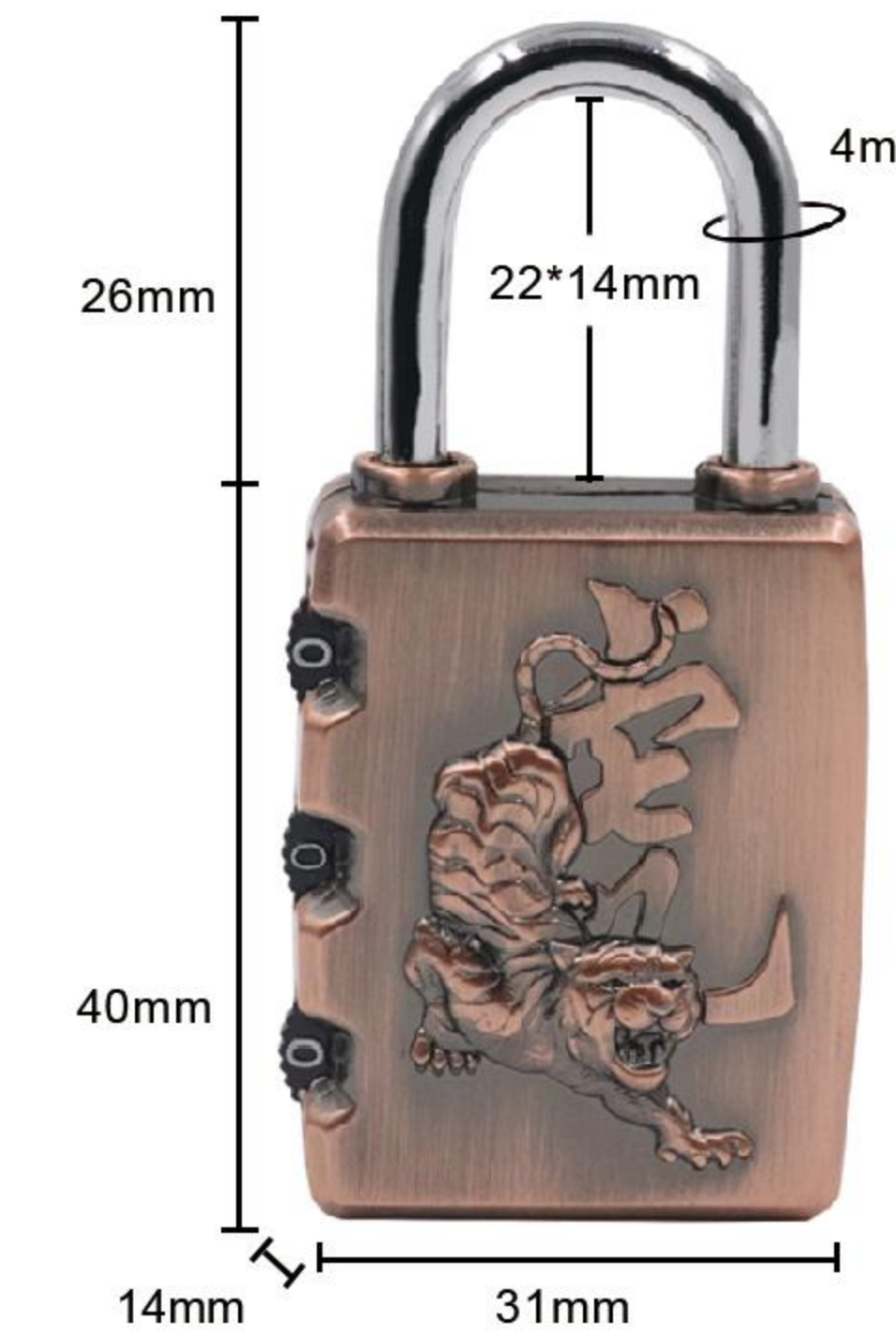

**Item:8028**  
 Size: 2.60\*1.22\*0.55in  
 Material: Zinc alloy  
 Weight: 38g



**Item:8023L**  
 Size: 2.56\*1.69\*0.83in  
 Material: Zinc alloy  
 Weight: 100g



**Item:8023A**  
 Size: 3.11\*1.71\*0.85in  
 Material: Zinc alloy  
 Weight: 61g

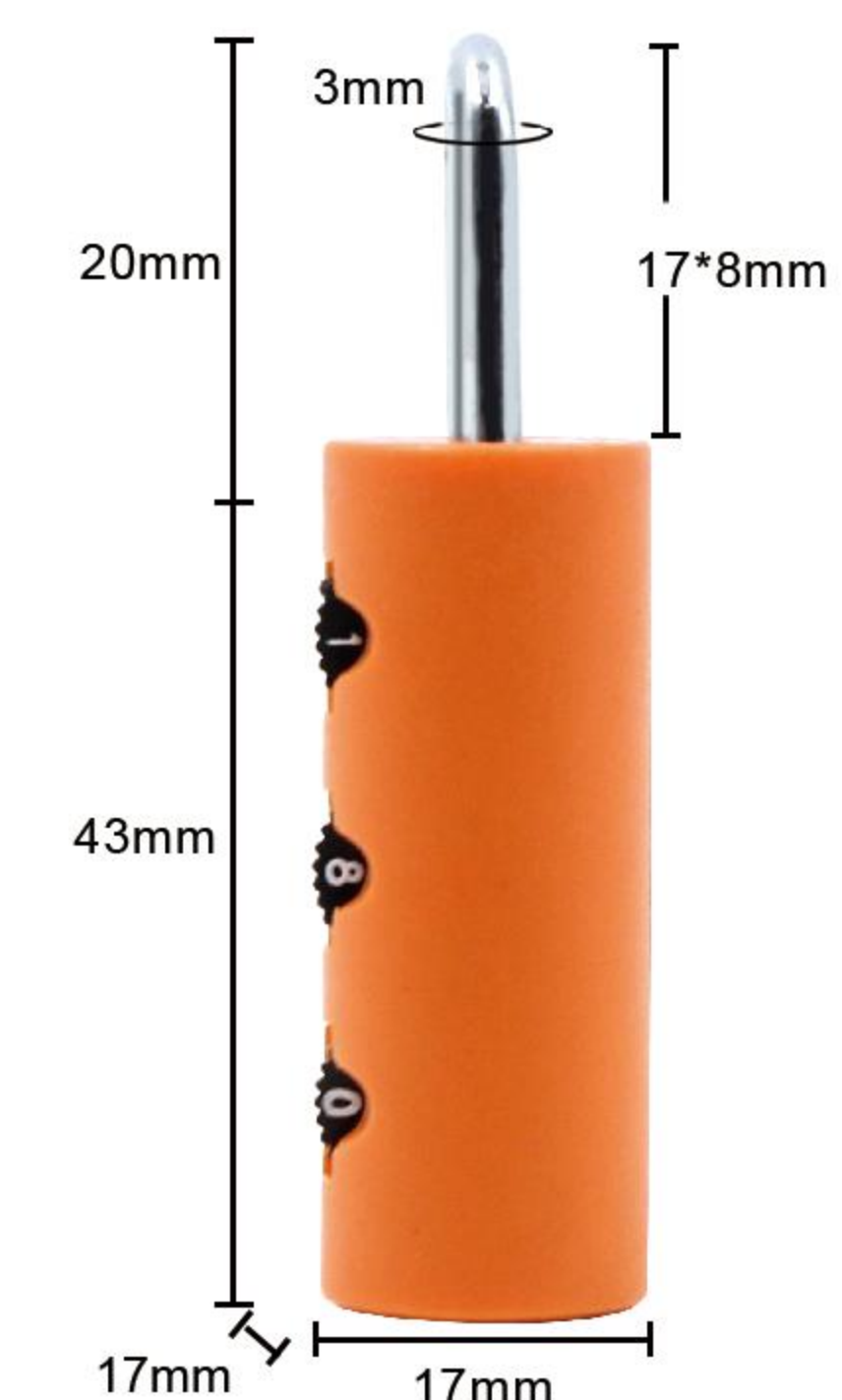

**Item:8029**  
 Size: 2.40\*0.67\*0.67in  
 Material: ABS plastic  
 Weight: 8.6g

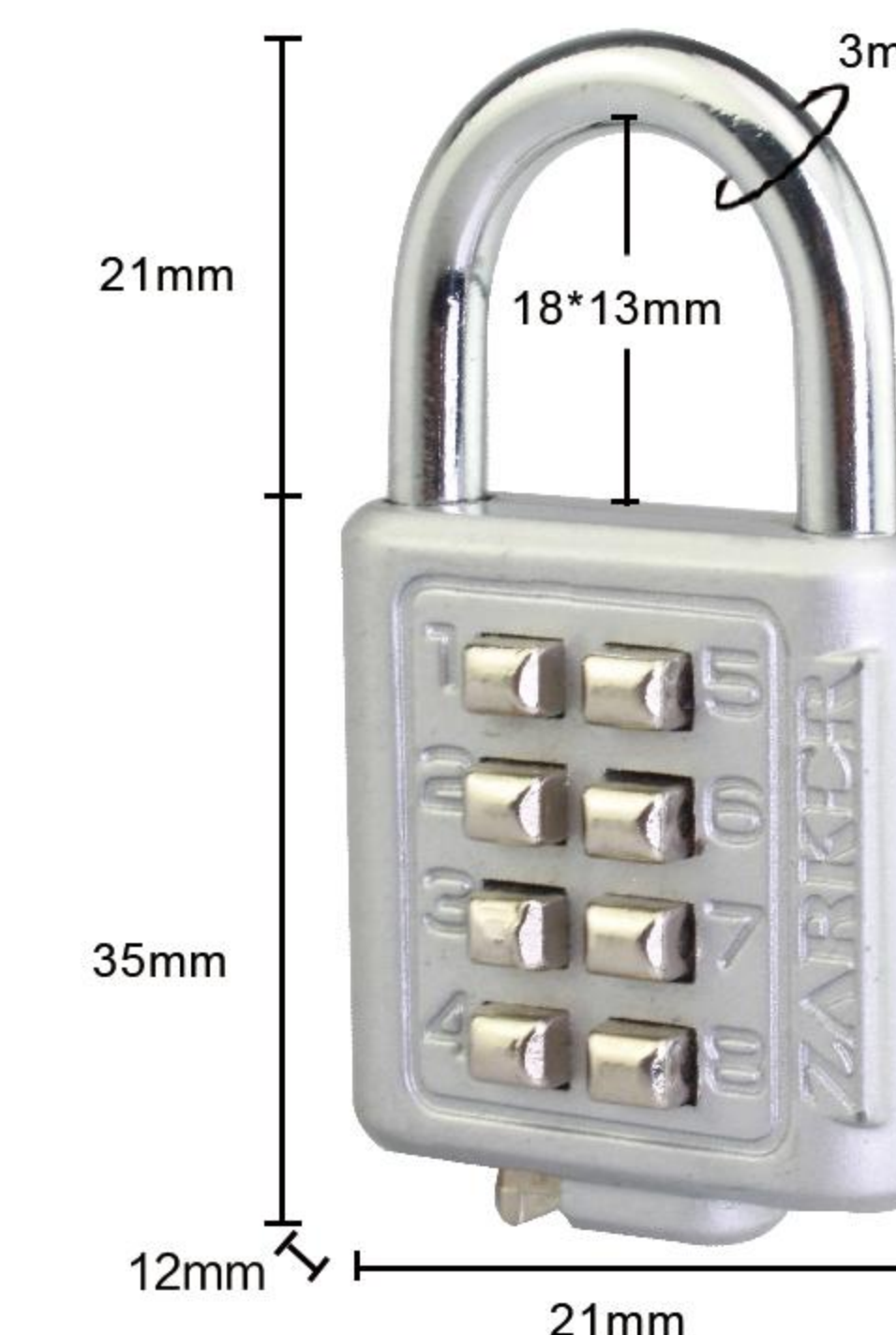

**Item:8030**  
 Size: 2.40\*0.94\*0.39in  
 Material: Zinc alloy  
 Weight: 15g

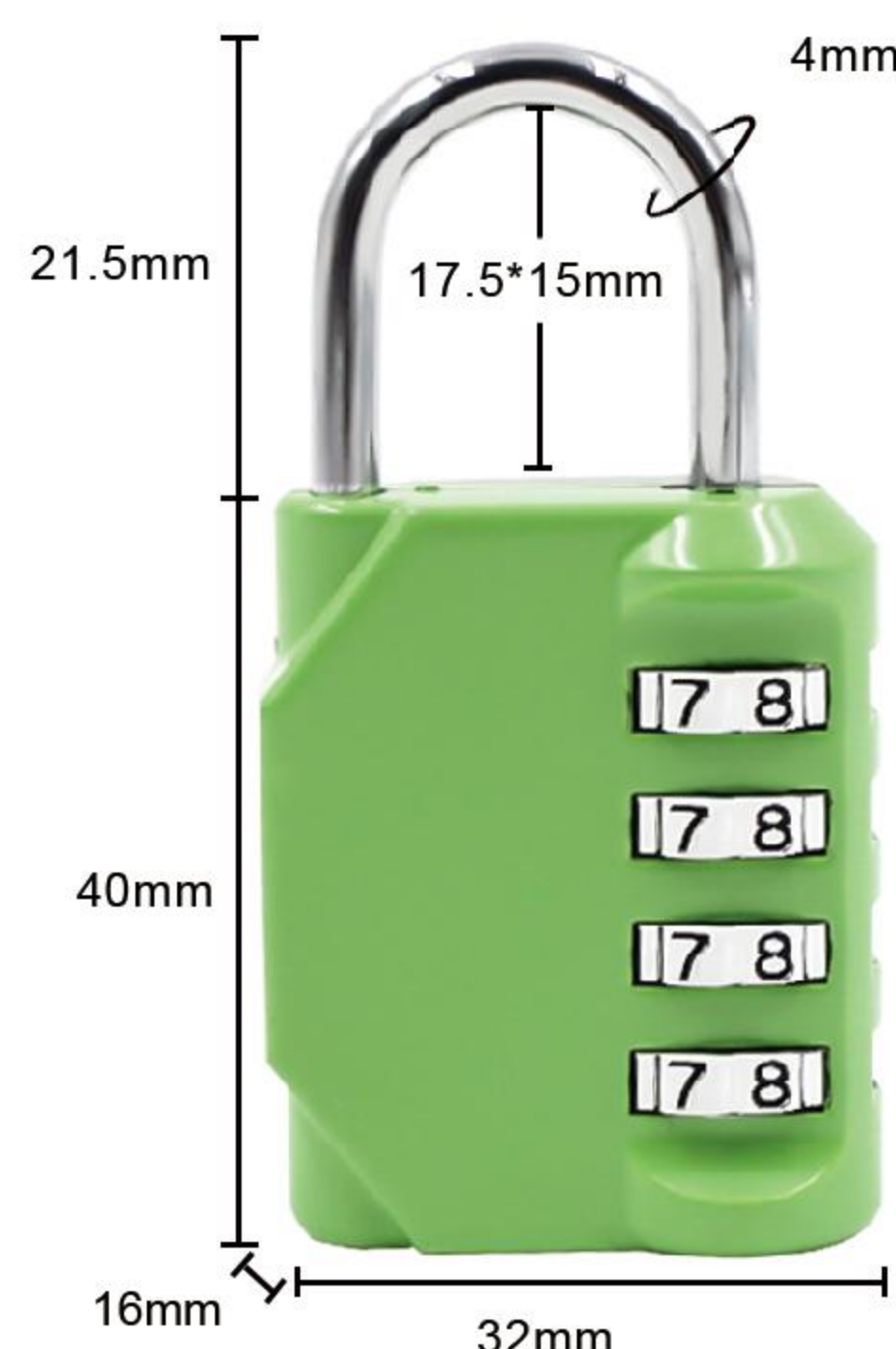

**Item:8023B**  
 Size: 2.42\*1.26\*0.63in  
 Material: Zinc alloy  
 Weight: 50.4g

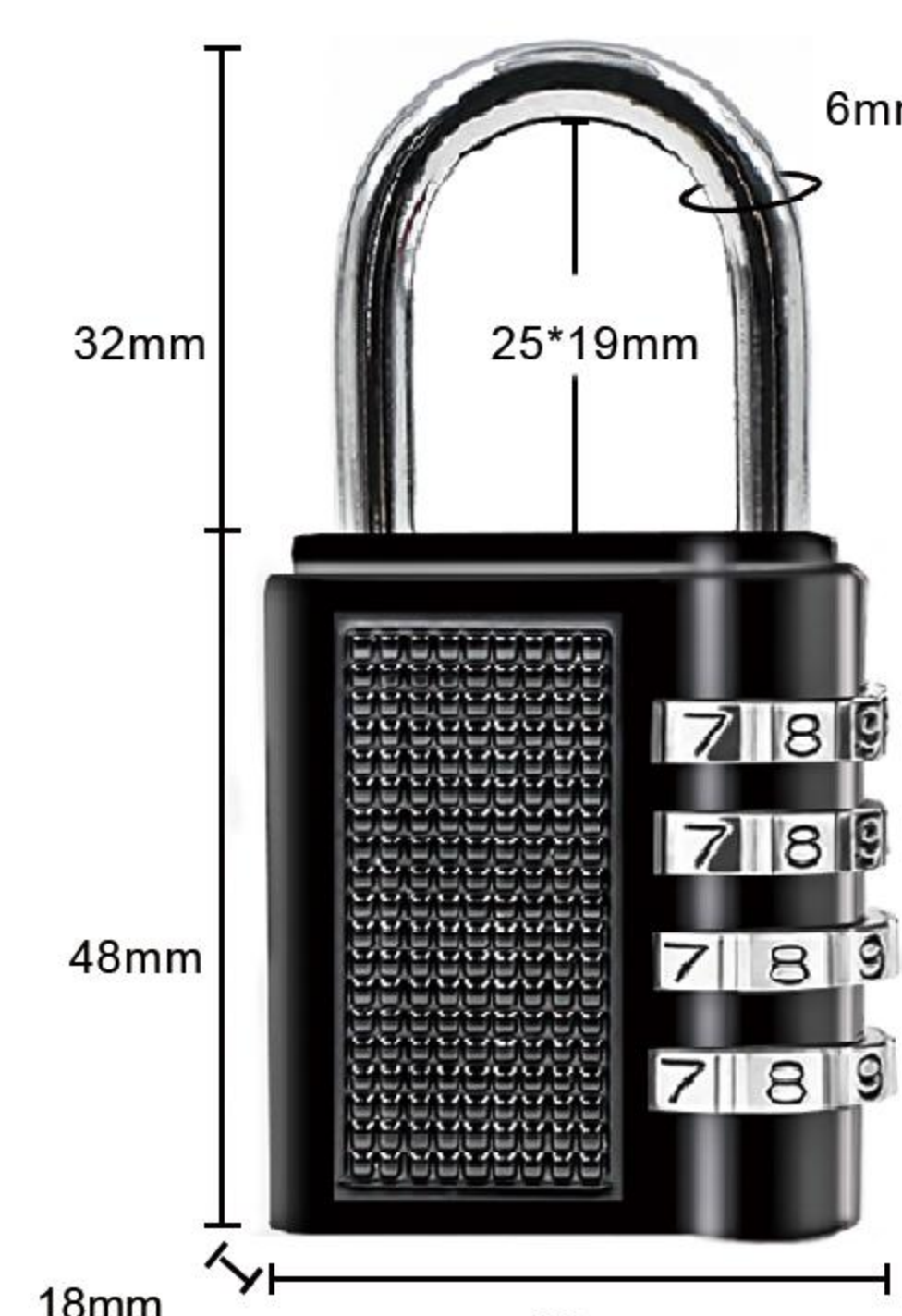

**Item:8024**  
 Size: 3.15\*1.65\*0.71in  
 Material: Zinc alloy  
 Weight: 102.2g



**Item:8030A**  
 Size: 2.60\*1.38\*0.59in  
 Material: Zinc alloy  
 Weight: 56.4g



**Item:8030B**  
 Size: 2.60\*1.38\*0.47in  
 Material: Zinc alloy  
 Weight: 61g

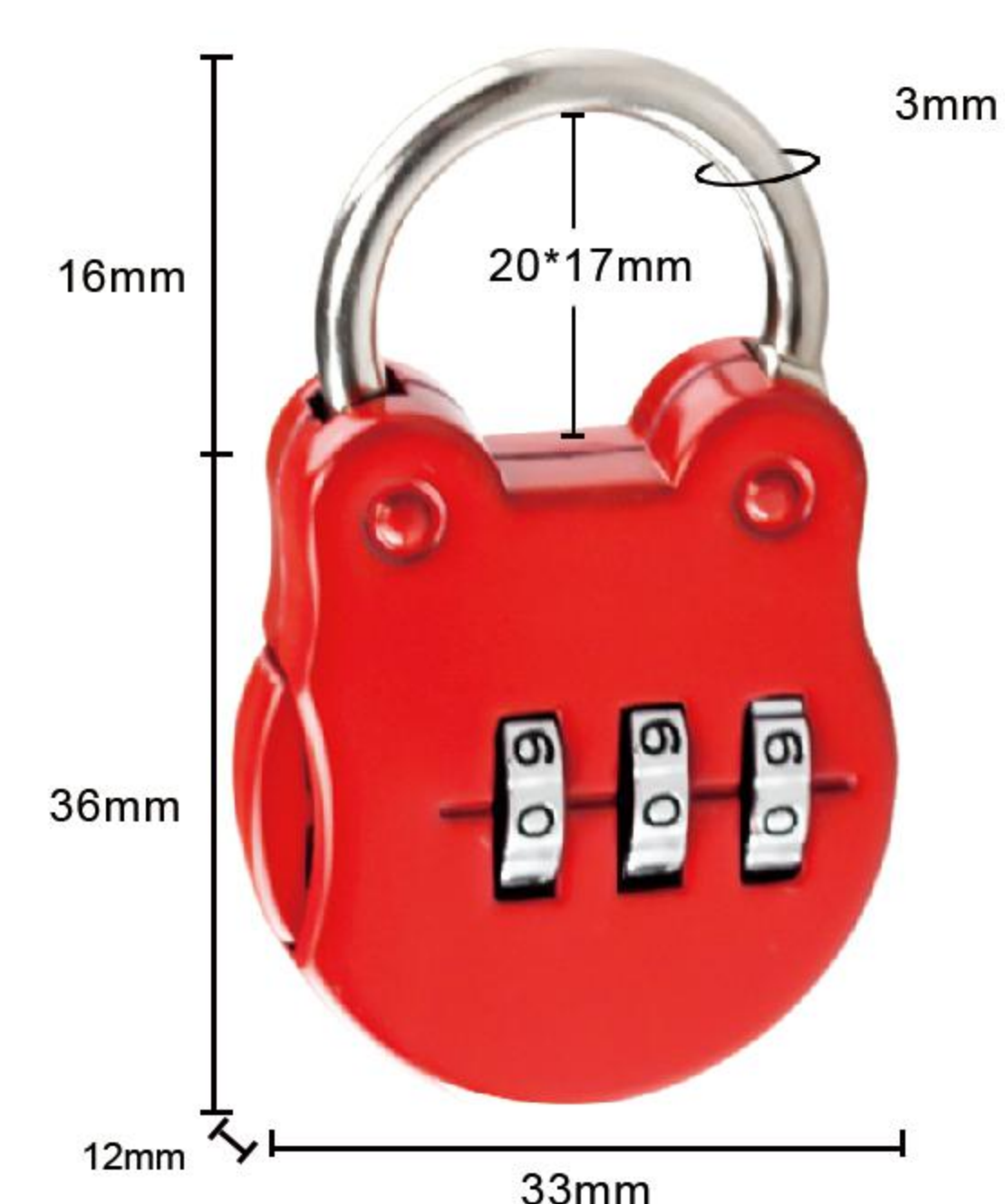

**Item:8025**  
 Size: 2.05\*1.30\*0.47in  
 Material: Zinc alloy  
 Weight: 23g

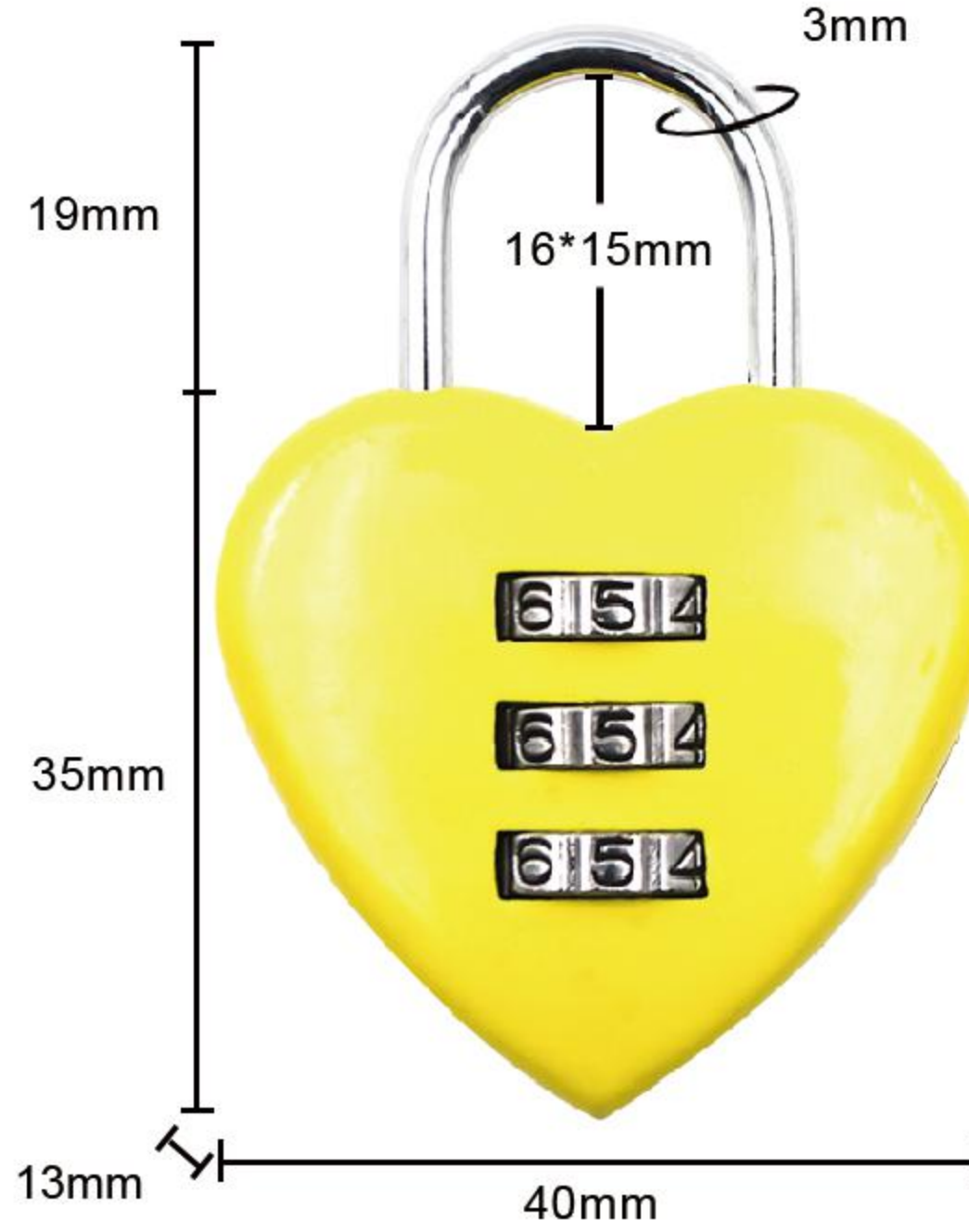

**Item:8026**  
 Size: 2.13\*1.57\*0.51in  
 Material: Zinc alloy  
 Weight: 25.6g

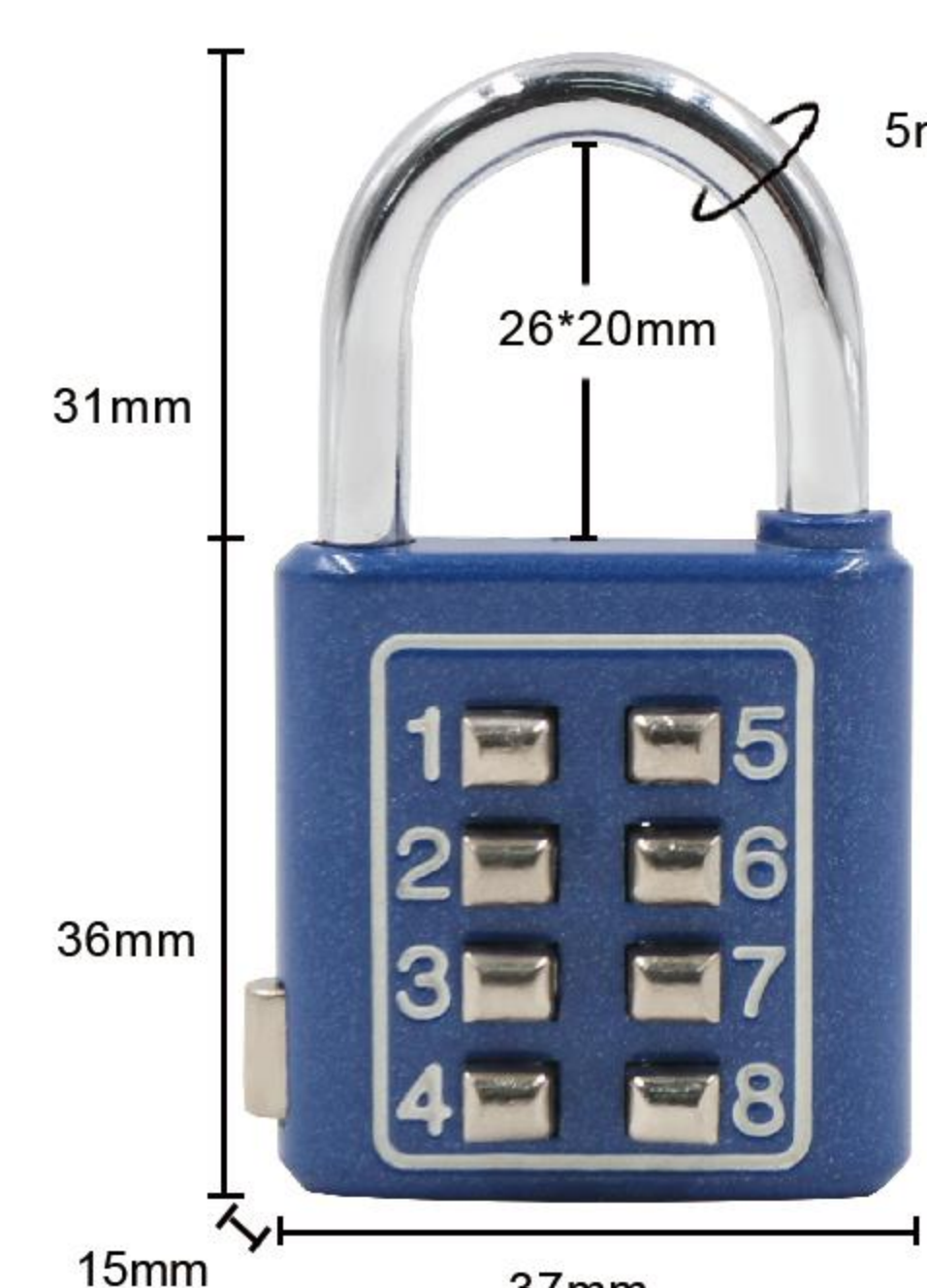

**Item:8030C**  
 Size: 2.64\*1.46\*0.59in  
 Material: Zinc alloy  
 Weight: 62g

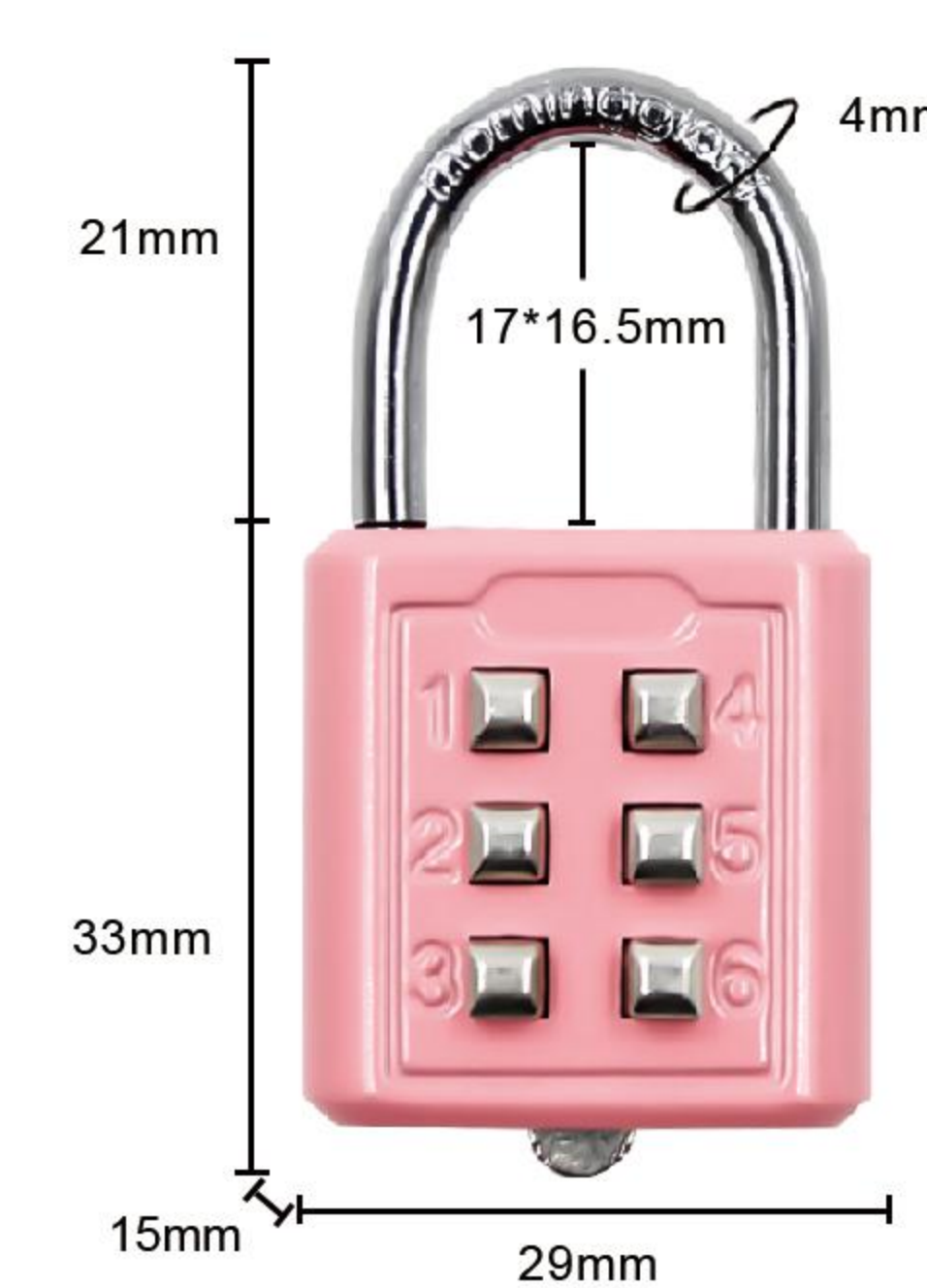

**Item:8030D**  
 Size: 2.12\*1.14\*0.59in  
 Material: Zinc alloy  
 Weight: 37.7g

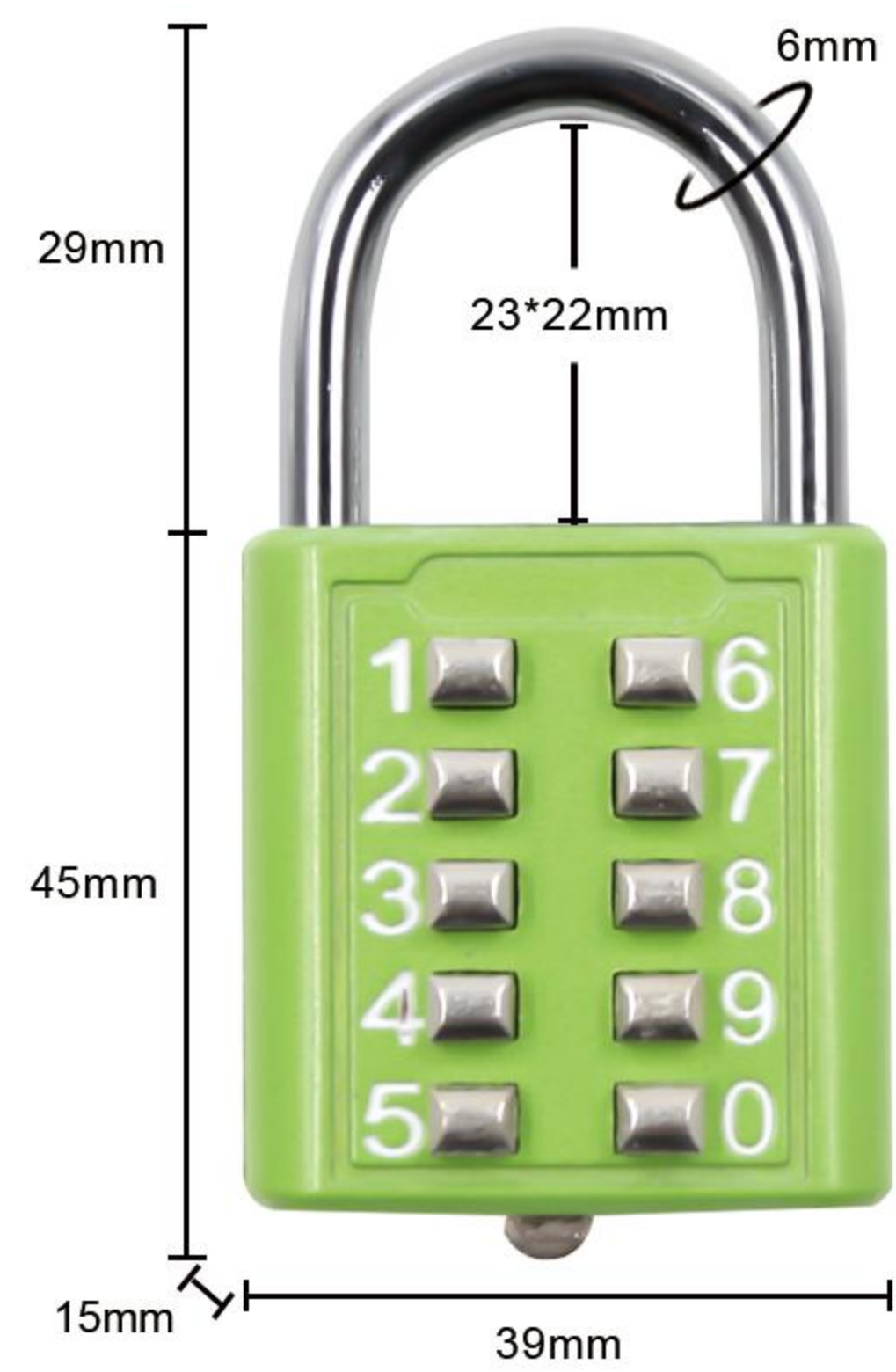

**Item:8031A**  
 Size: 2.91\*1.53\*0.59in  
 Material: Zinc alloy  
 Weight: 78g



**Item:8031B**  
 Size: 2.79\*1.65\*0.59in  
 Material: Zinc alloy  
 Weight: 78g

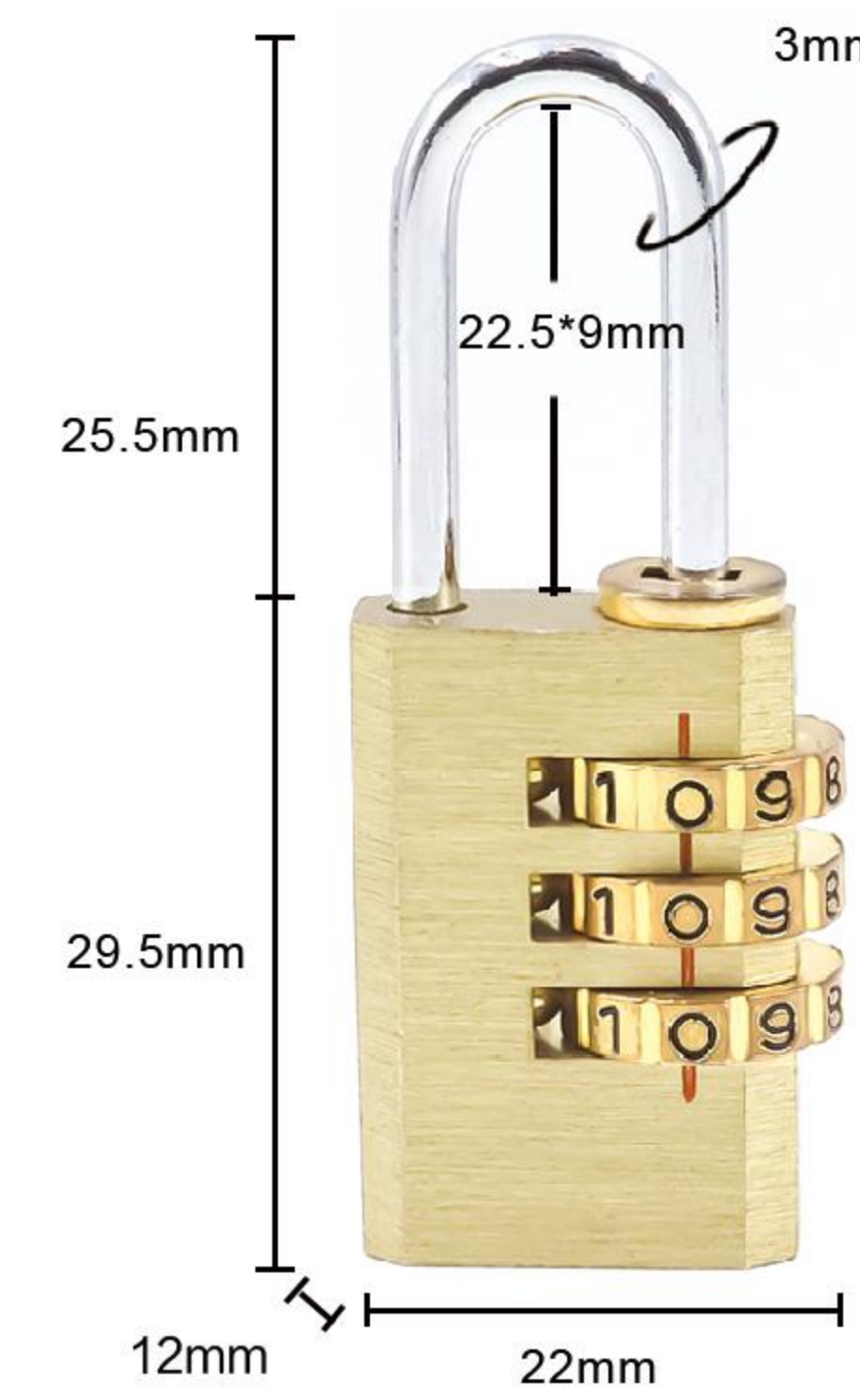

**Item:8040**  
 Size: 1.16\*0.87\*0.51in  
 Material: Brass  
 Weight: 37g

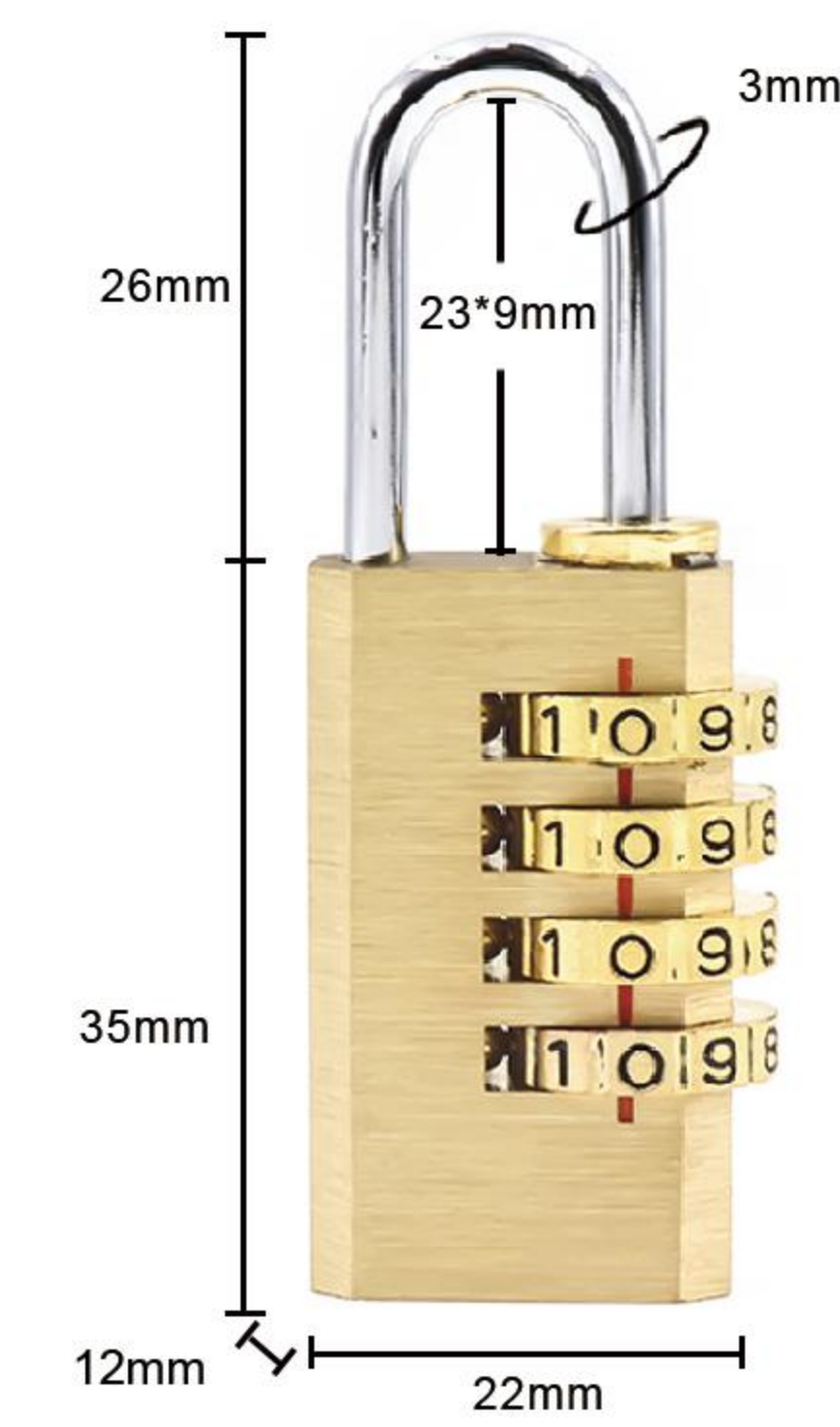

**Item:8041**  
 Size: 2.40\*0.87\*0.53in  
 Material: Brass  
 Weight: 56.5g

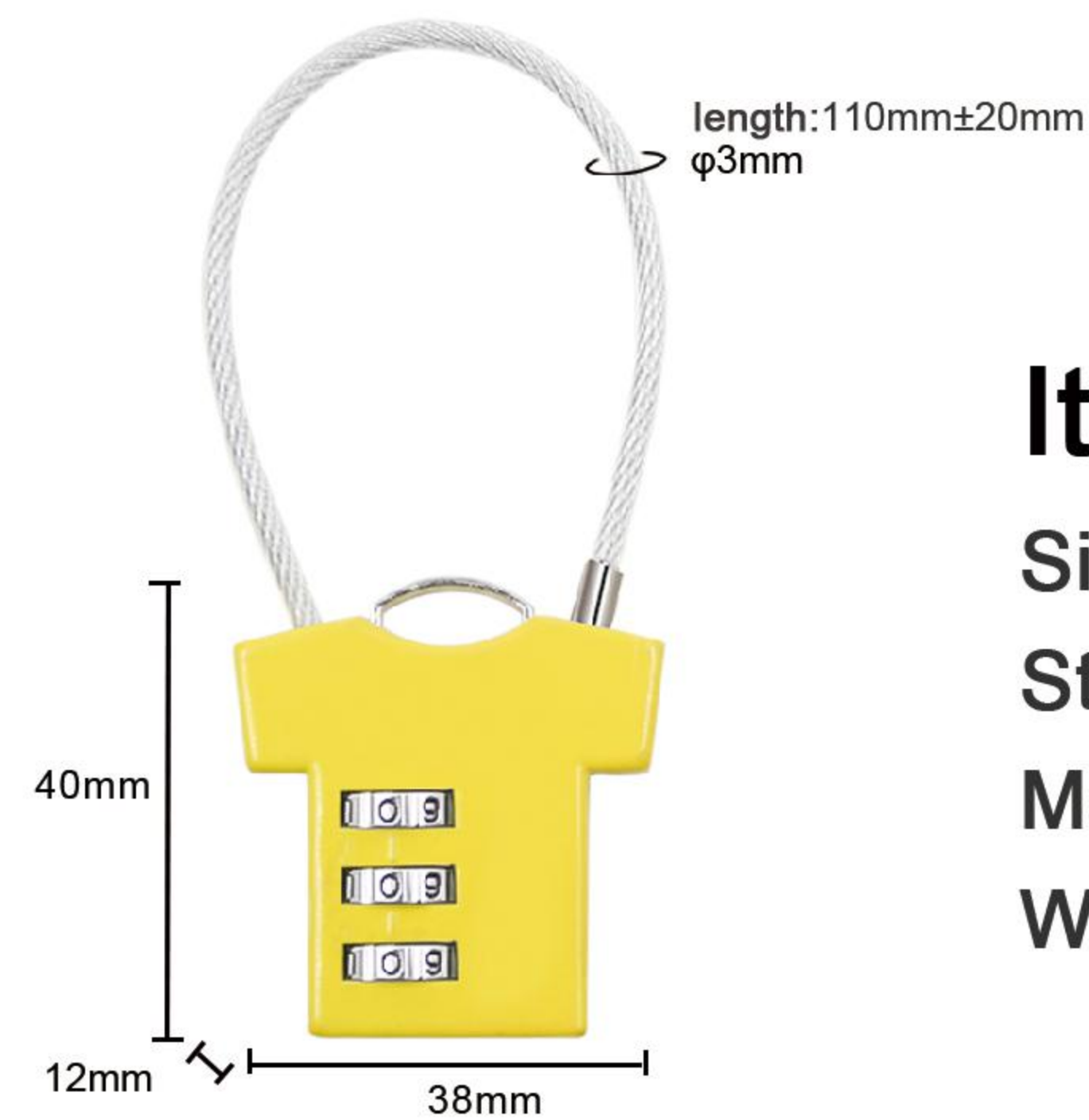

**Item:8032**  
 Size: 1.57\*1.50\*0.47in  
 Steel wire: 4.33±0.79in  
 Material: Zinc alloy  
 Weight: 27.9g



**Item:8034**  
 Size: 2.36\*1.10\*0.63in  
 Material: Zinc alloy  
 Weight: 26.5g

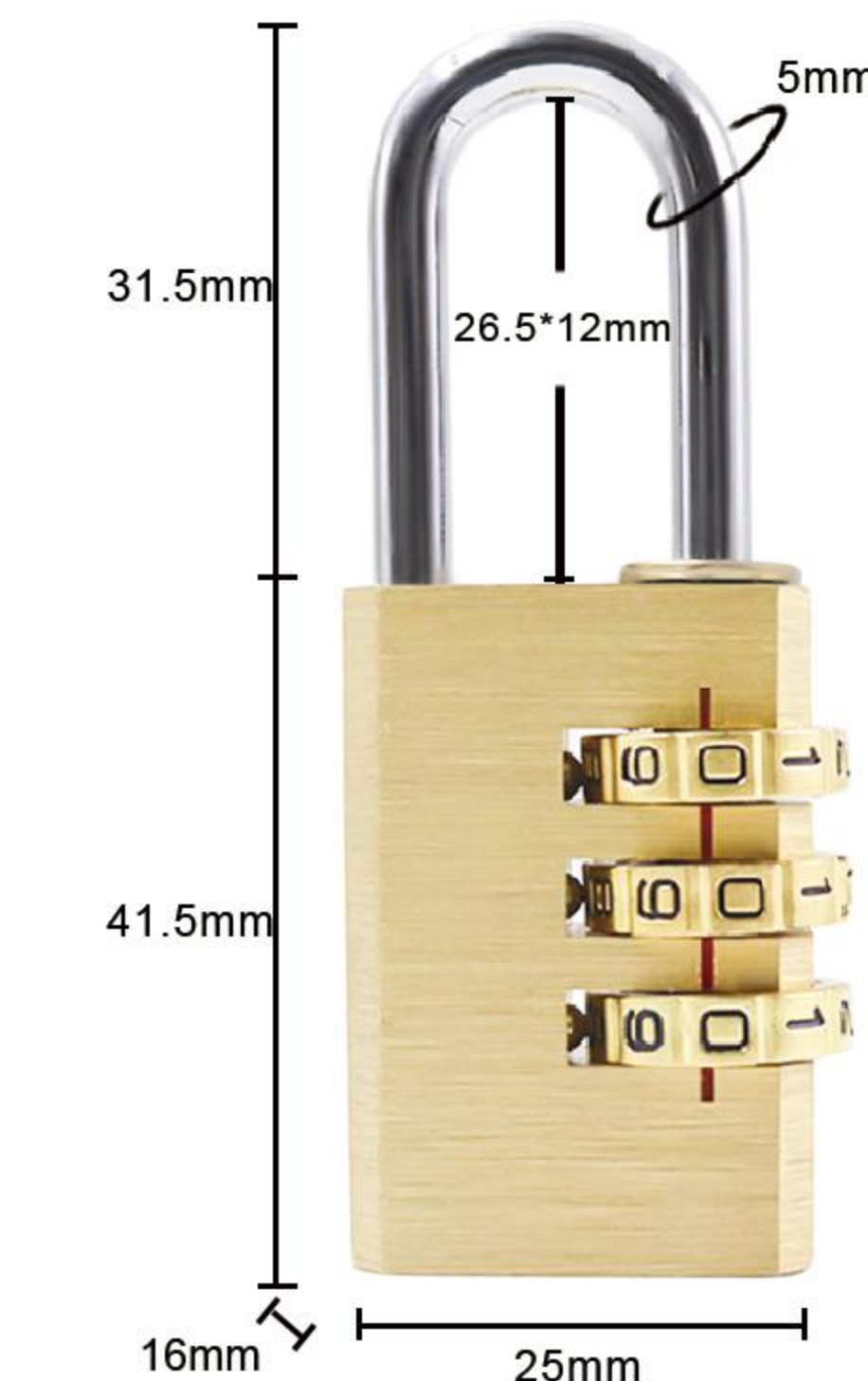

**Item:8042**  
 Size: 2.87\*1.18\*0.63in  
 Material: Brass  
 Weight: 86.8g

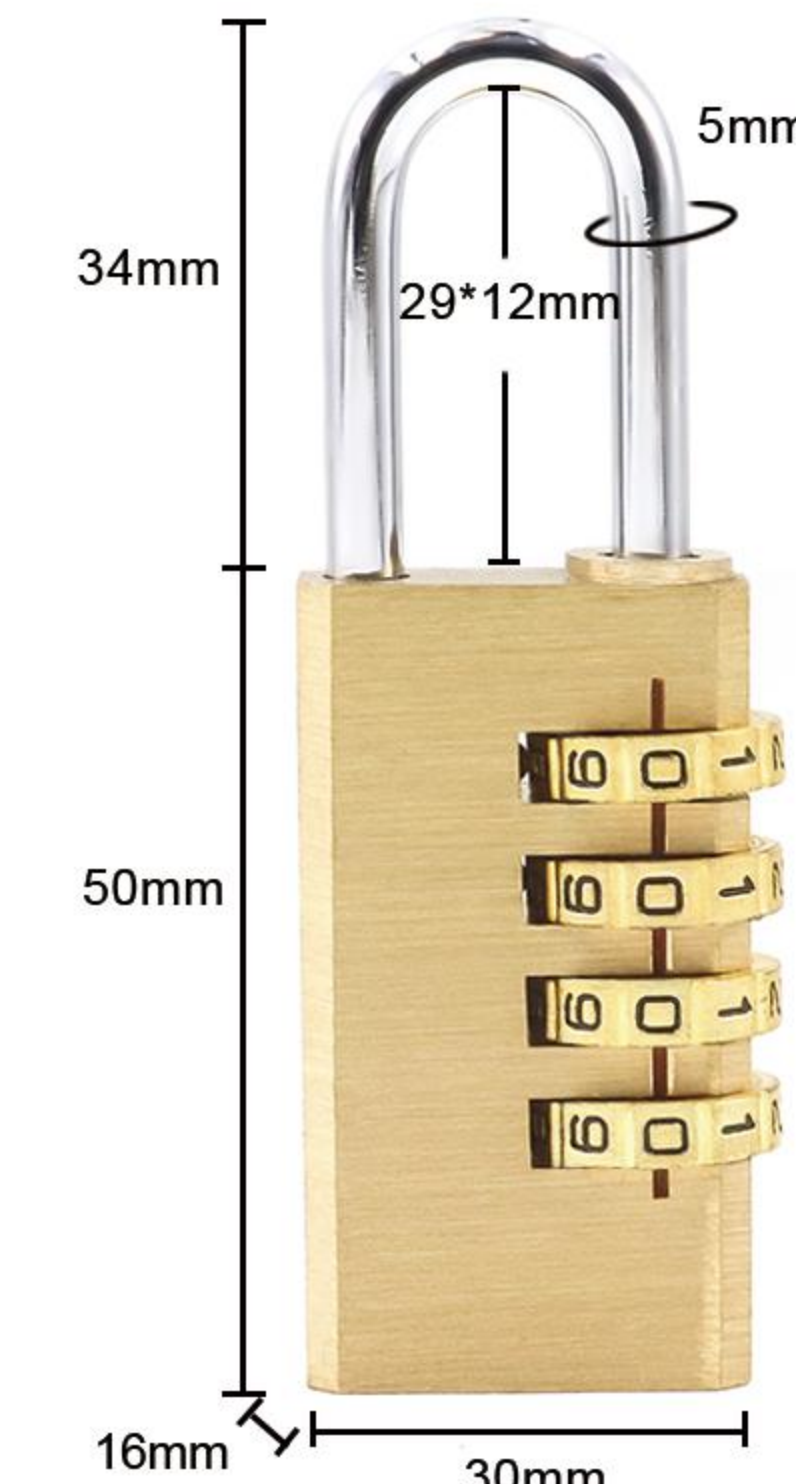

**Item:8043**  
 Size: 3.31\*1.18\*0.63in  
 Material: Brass  
 Weight: 106g



**Item:8035**  
 Size: 1.62\*1.42\*0.47in  
 Material: Zinc alloy  
 Weight: 26.8g



**Item:8036**  
 Size: 2.48\*1.10\*0.43in  
 Material: Zinc alloy  
 Weight: 27g

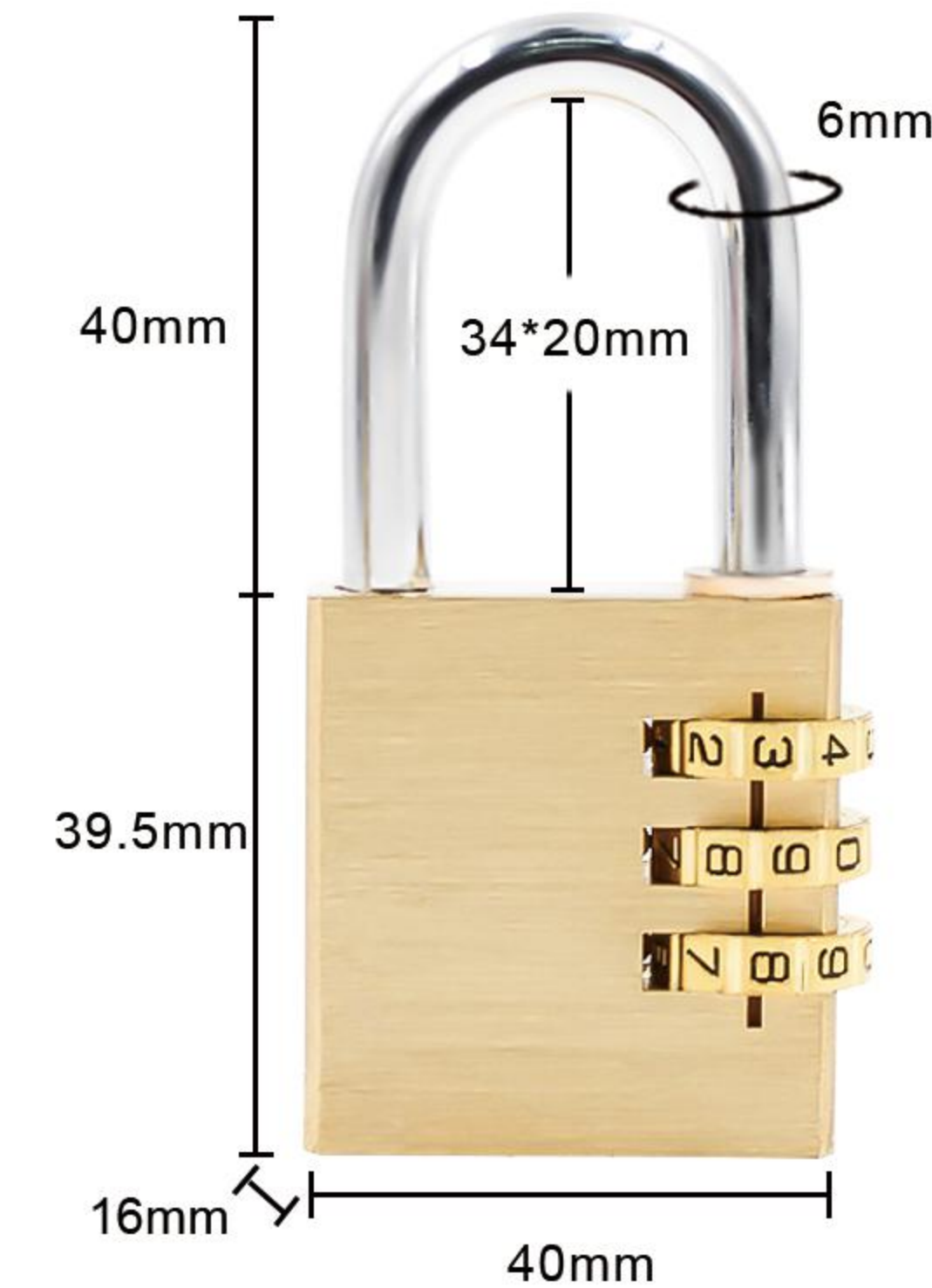

**Item:8044**  
 Size: 3.13\*1.57\*0.63in  
 Material: Brass  
 Weight: 143.3g

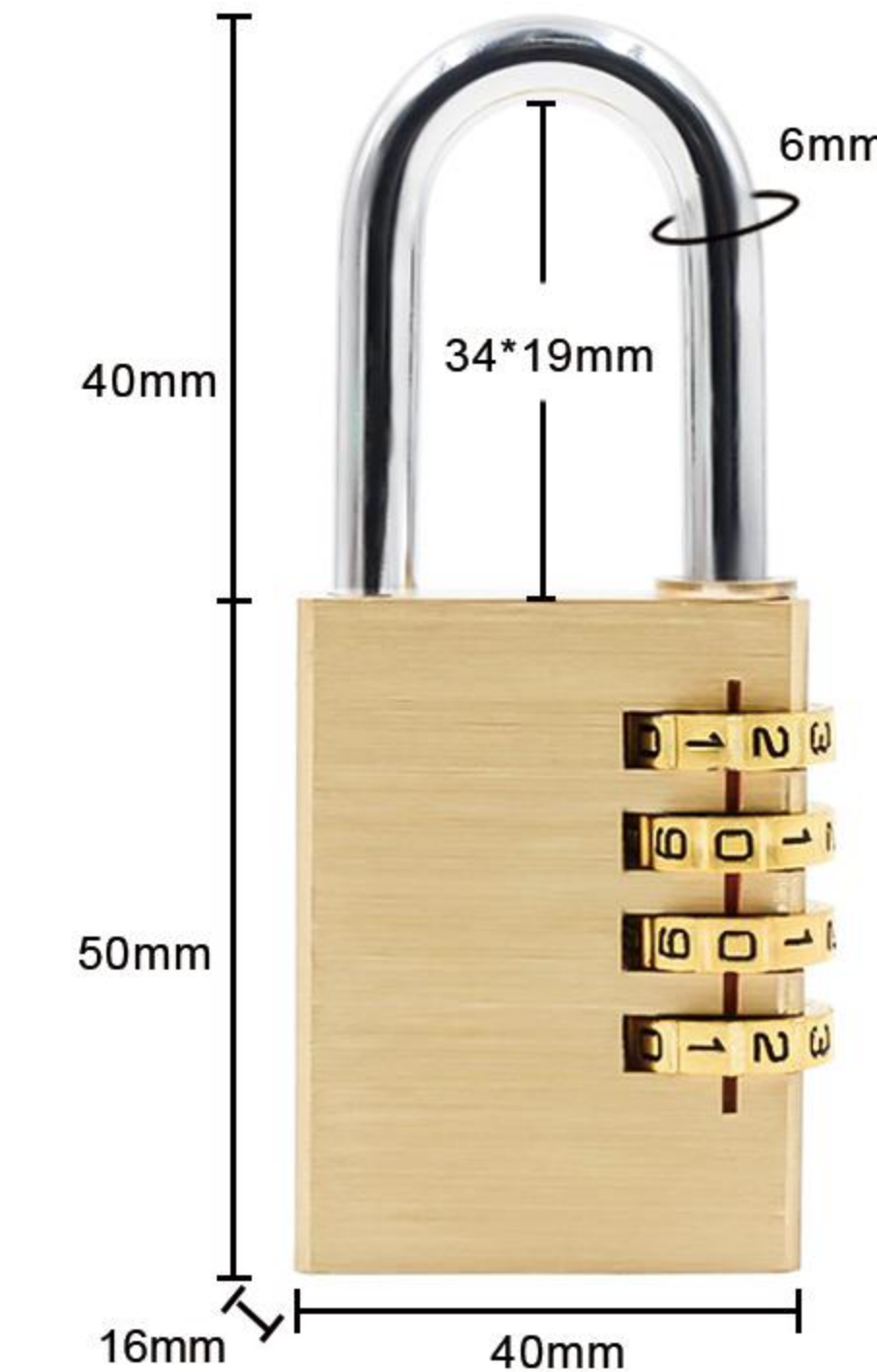

**Item:8045**  
 Size: 3.54\*1.57\*0.63in  
 Material: Brass  
 Weight: 169.5g

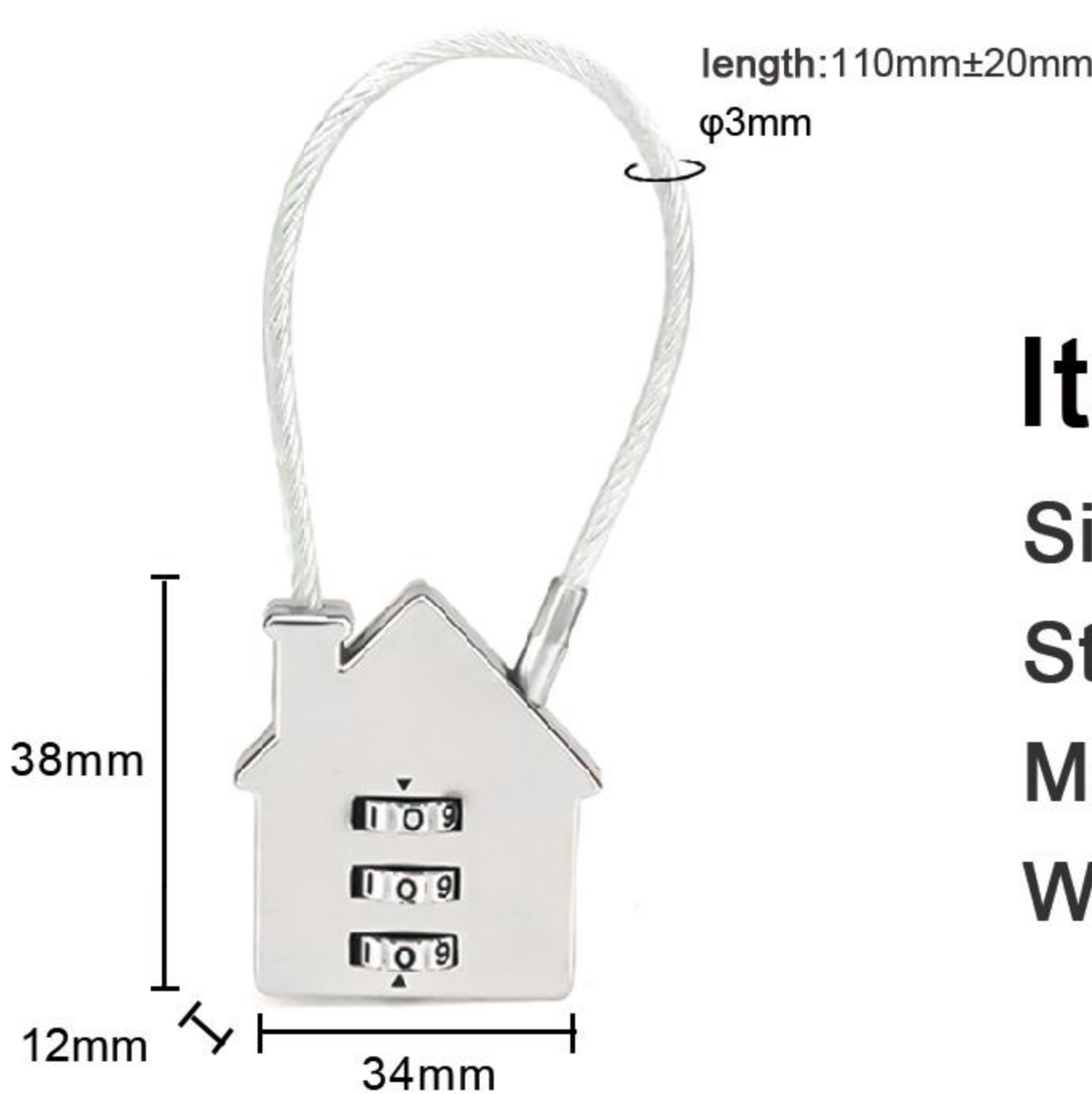

**Item:8038**  
 Size: 1.50\*1.34\*0.47in  
 Steel wire: 4.33±0.79in  
 Material: Zinc alloy  
 Weight: 32g



**Item:8039**  
 Size: 1.54\*1.46\*0.47in  
 Steel wire: 4.33±0.79in  
 Material: Zinc alloy  
 Weight: 32.7g



**Item:8046A**  
 Size: 2.91\*1.57\*0.39in  
 Material: Aluminum alloy  
 Weight: 26.9g



**Item:8046B**  
 Size: 3.74\*2.21\*0.30in  
 Material: Aluminum alloy  
 Weight: 54.1g



**Item:8046C**  
 Size: 4.25\*2.40\*0.47in  
 Material: Aluminum alloy  
 Weight: 62.2g

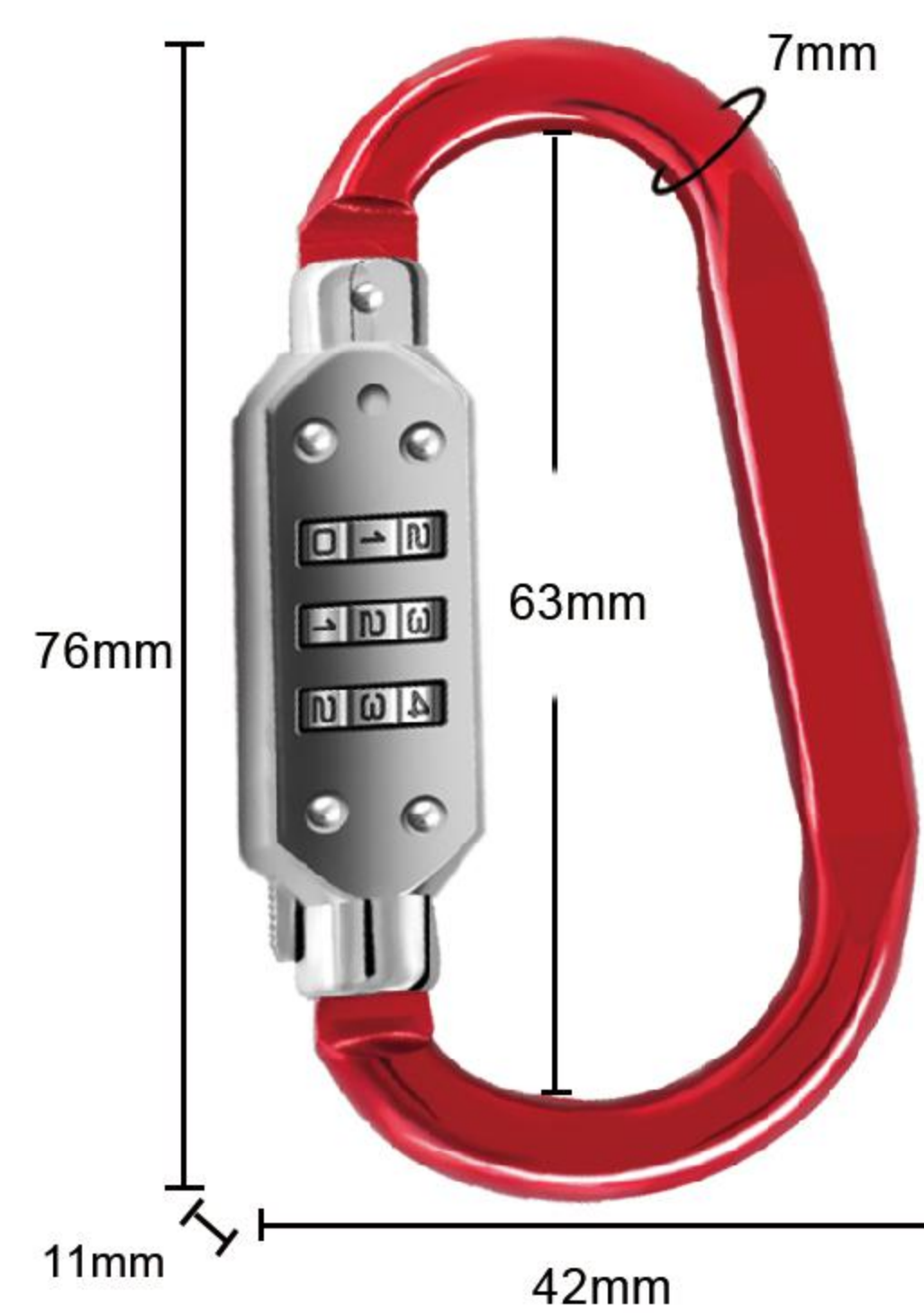

**Item:8047**  
 Size: 2.99\*1.65\*0.43in  
 Material: Zinc alloy  
 Weight: 32g



**Item:8055**  
 Size: 1.42\*1.57\*0.63in  
 Steel wire: 4.33±0.79in  
 Material: Zinc alloy  
 Weight: 35g



**Item:8056A**  
 Size: 2.40\*0.94\*0.39in  
 Material: Zinc alloy  
 Weight: 53g



**Item:8047A**  
 Size: 3.78\*2.17\*0.43in  
 Material: Aluminum alloy  
 Weight: 64g

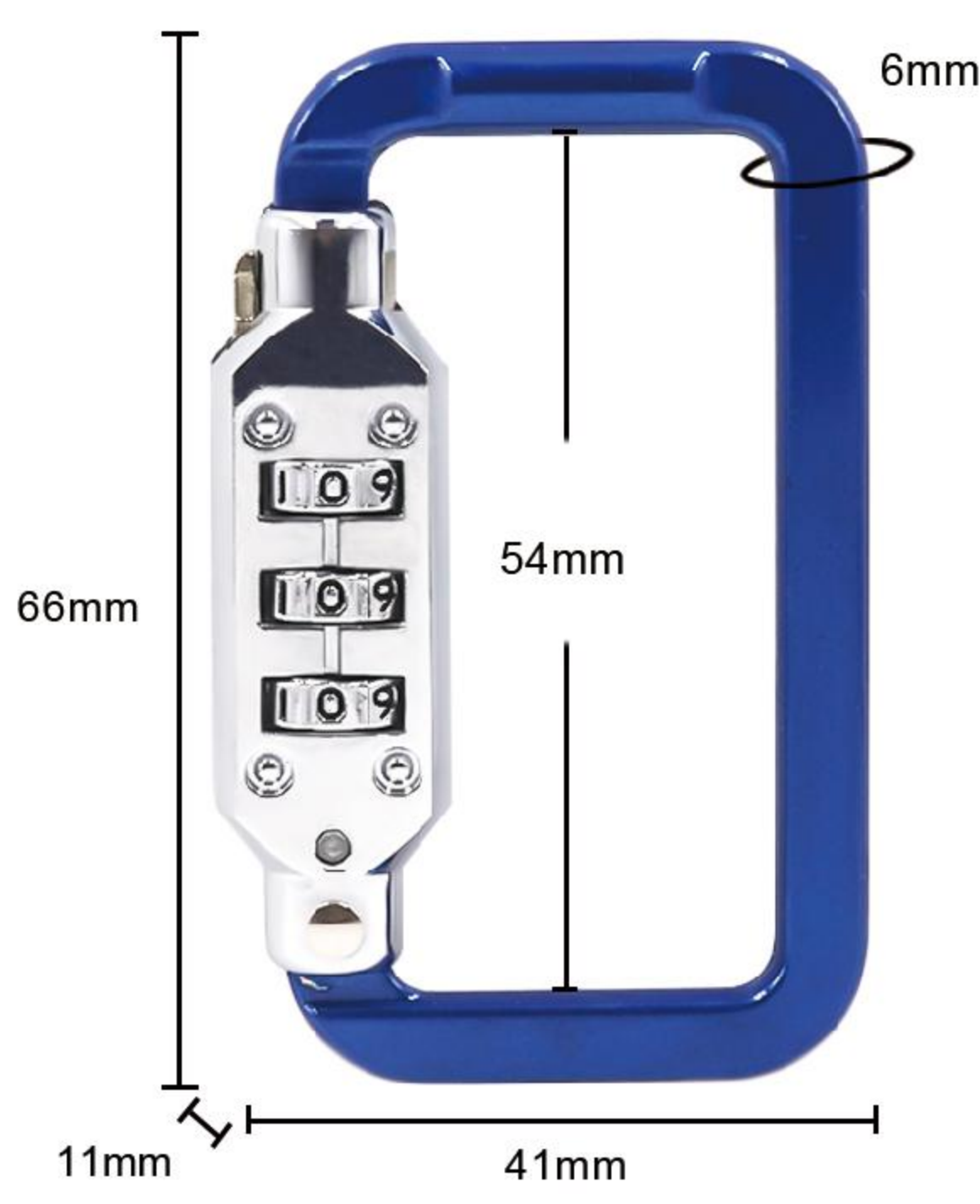

**Item:8048**  
 Size: 2.60\*1.61\*0.43in  
 Material: Zinc alloy  
 Weight: 41g

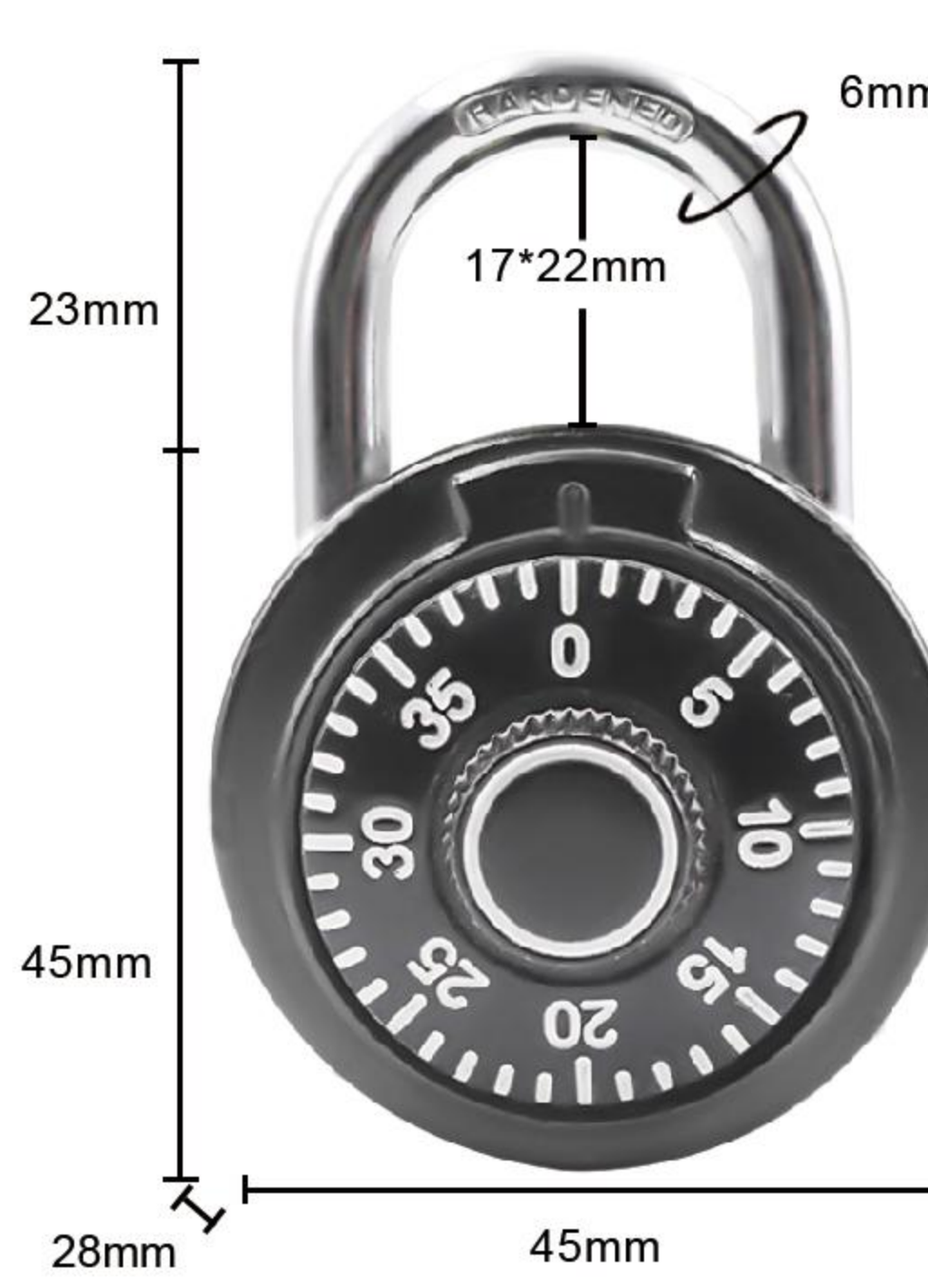

**Item:8056B**  
 Size: 2.68\*1.77\*1.10in  
 Material: Zinc alloy  
 Weight: 85g



**Item:8056C**  
 Size: 2.99\*1.97\*1.22in  
 Material: Zinc alloy  
 Weight: 132g



**Item:8050**  
 Size: 1.50\*1.02\*0.47in  
 Steel wire: 4.33±0.79in  
 Material: Zinc alloy  
 Weight: 36g

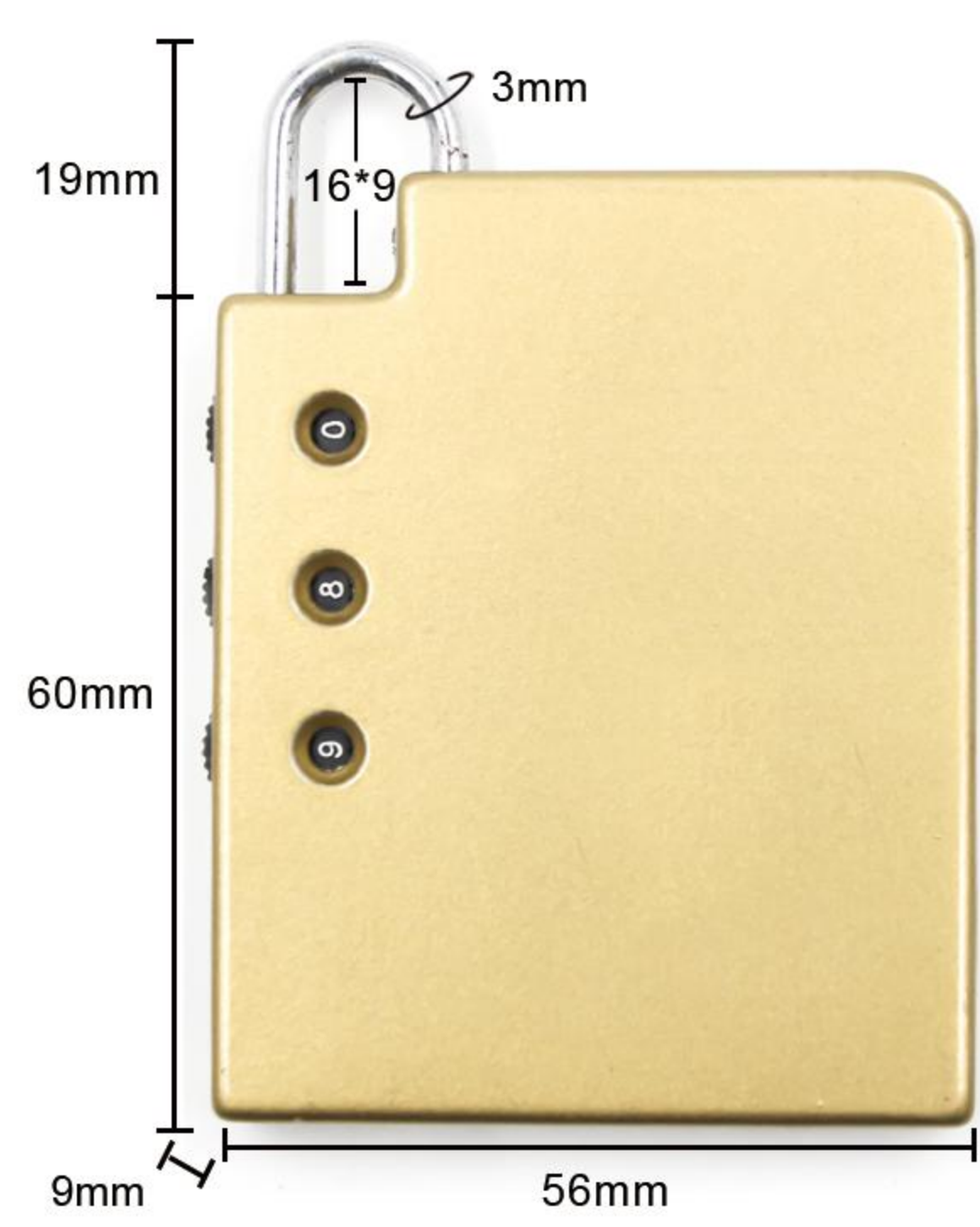

**Item:8051**  
 Size: 3.11\*2.20\*0.35in  
 Material: Zinc alloy  
 Weight: 77g

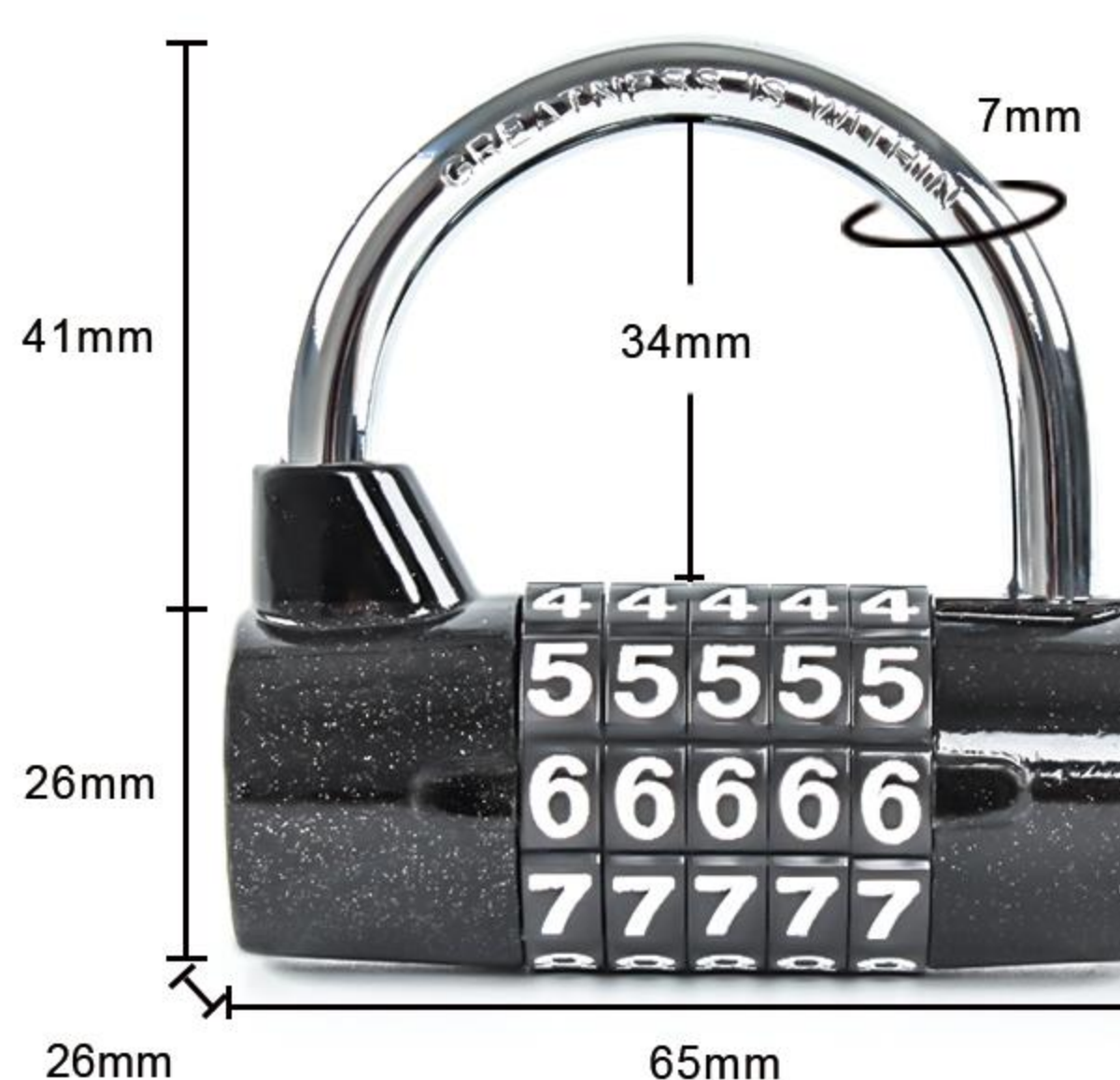

**Item:8057**  
 Size: 2.56\*2.52\*1.02in  
 Material: Zinc alloy  
 Weight: 152g

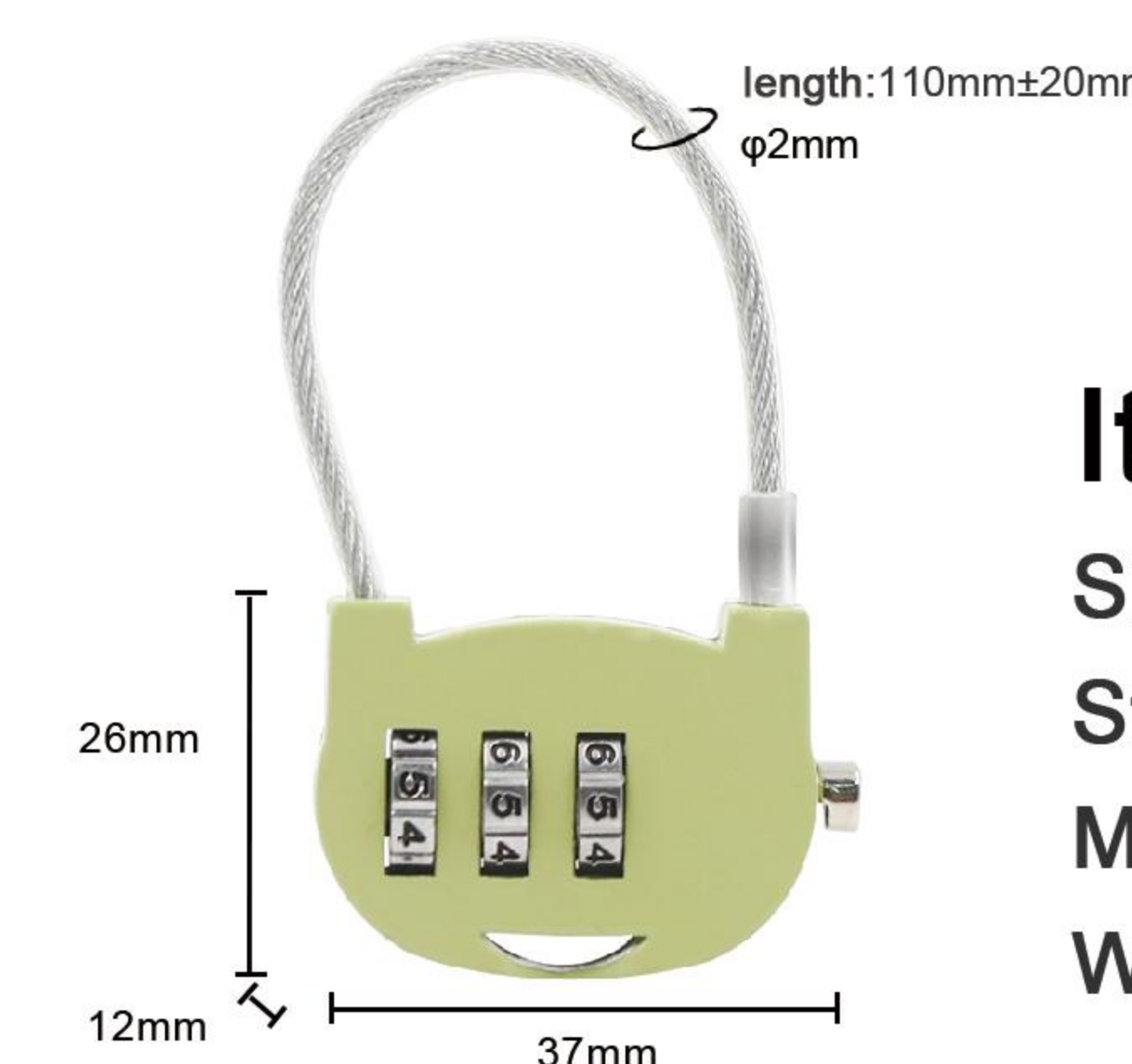

**Item:8060**  
 Size: 1.45\*1.02\*0.47in  
 Steel wire: 4.33±0.79in  
 Material: Zinc alloy  
 Weight: 23g



**Item:8052**  
 Size: 3.15\*0.94\*0.39in  
 Steel wire: 4.33±0.79in  
 Material: Zinc alloy  
 Weight: 77g

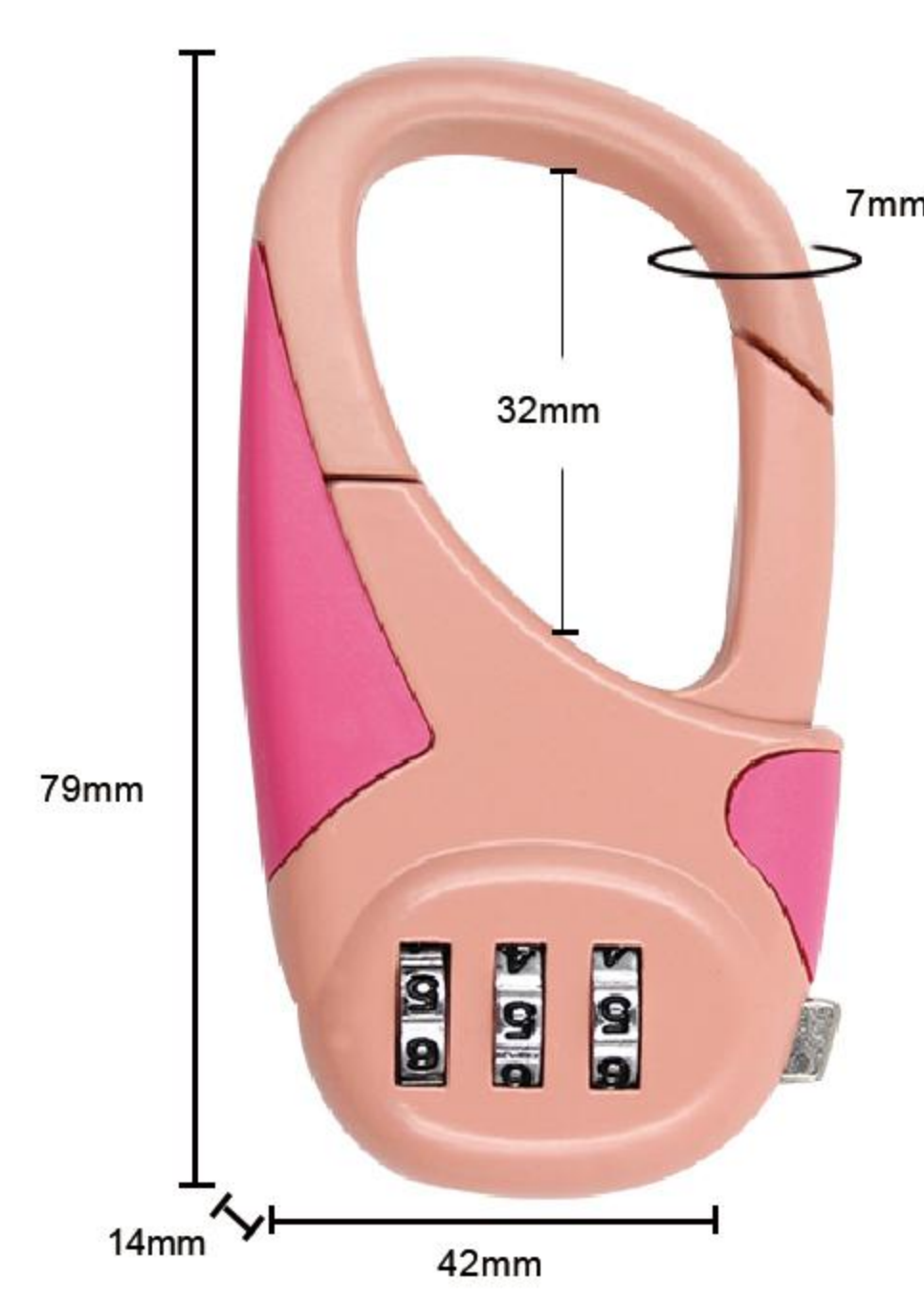

**Item:8054**  
 Size: 3.11\*1.65\*0.55in  
 Material: Zinc alloy  
 Weight: 64.1g

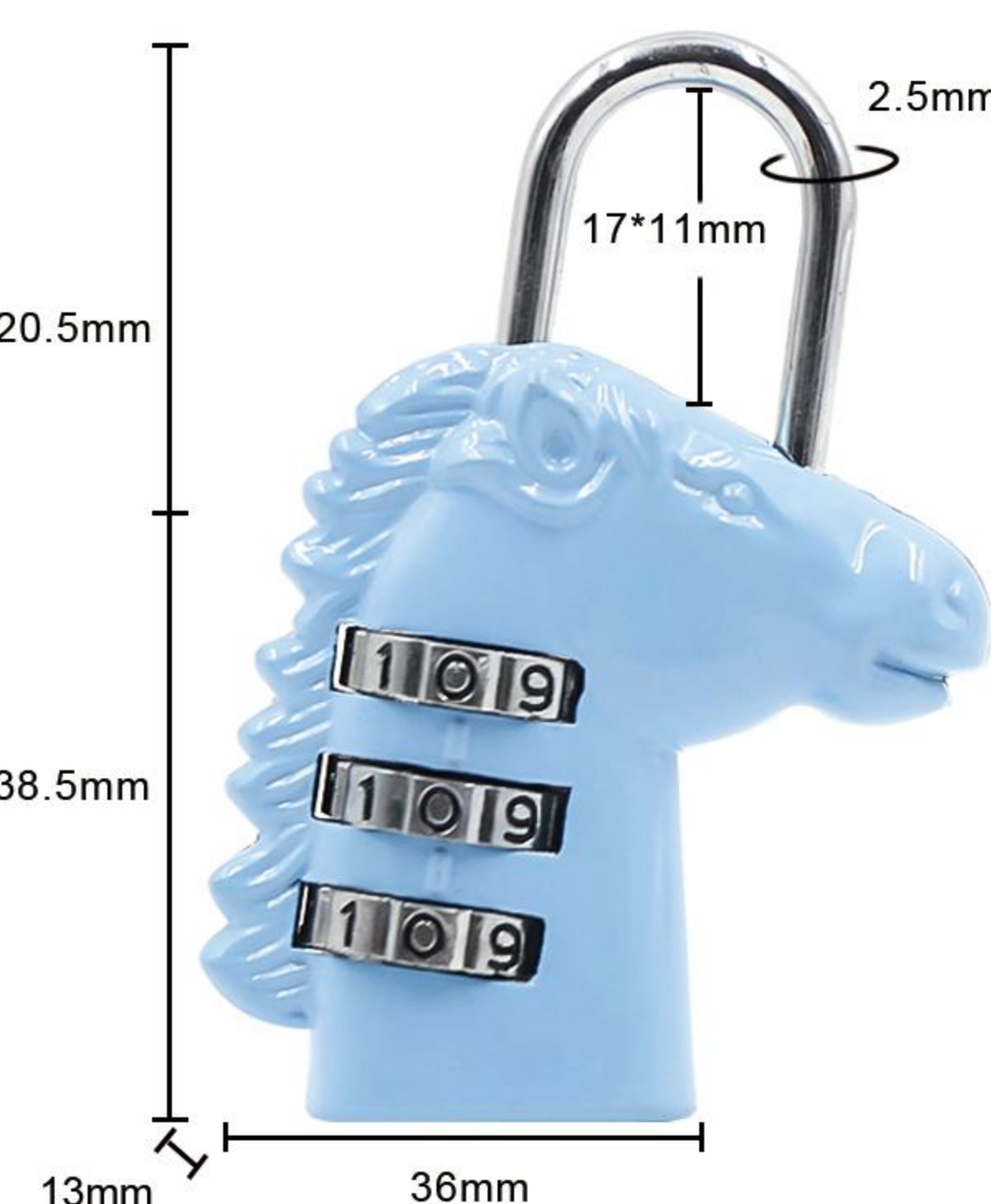

**Item:8061**  
 Size: 2.32\*1.42\*0.51in  
 Material: Zinc alloy  
 Weight: 24.8g



**Item:8062**  
 Size: 1.77\*1.18\*0.47in  
 Material: Zinc alloy  
 Weight: 16.5g



**Item:8063**  
 Size: 2.87\*1.69\*0.71in  
 Material: Zinc alloy  
 Weight: 112g

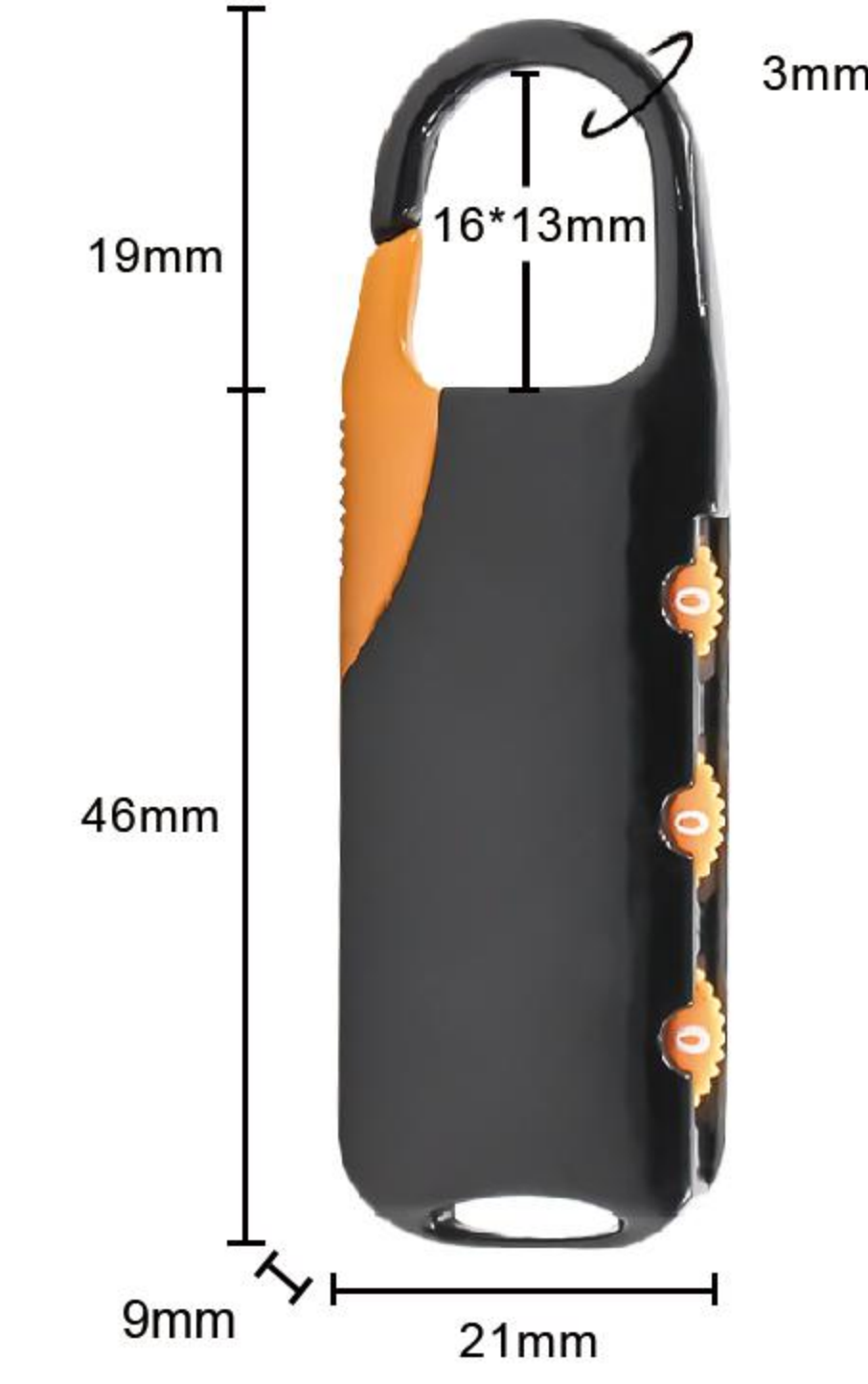

**Item:8064**  
 Size: 2.56\*0.82\*0.35in  
 Material: Zinc alloy  
 Weight: 26g



**Item:8070**  
 Size: 1.30\*1.65\*0.31in  
 Steel wire: 4.33±0.79in  
 Material: Zinc alloy  
 Weight: 32g



**Item:8071**  
 Size: 2.44\*1.30\*0.59in  
 Material: Zinc alloy  
 Weight: 47g

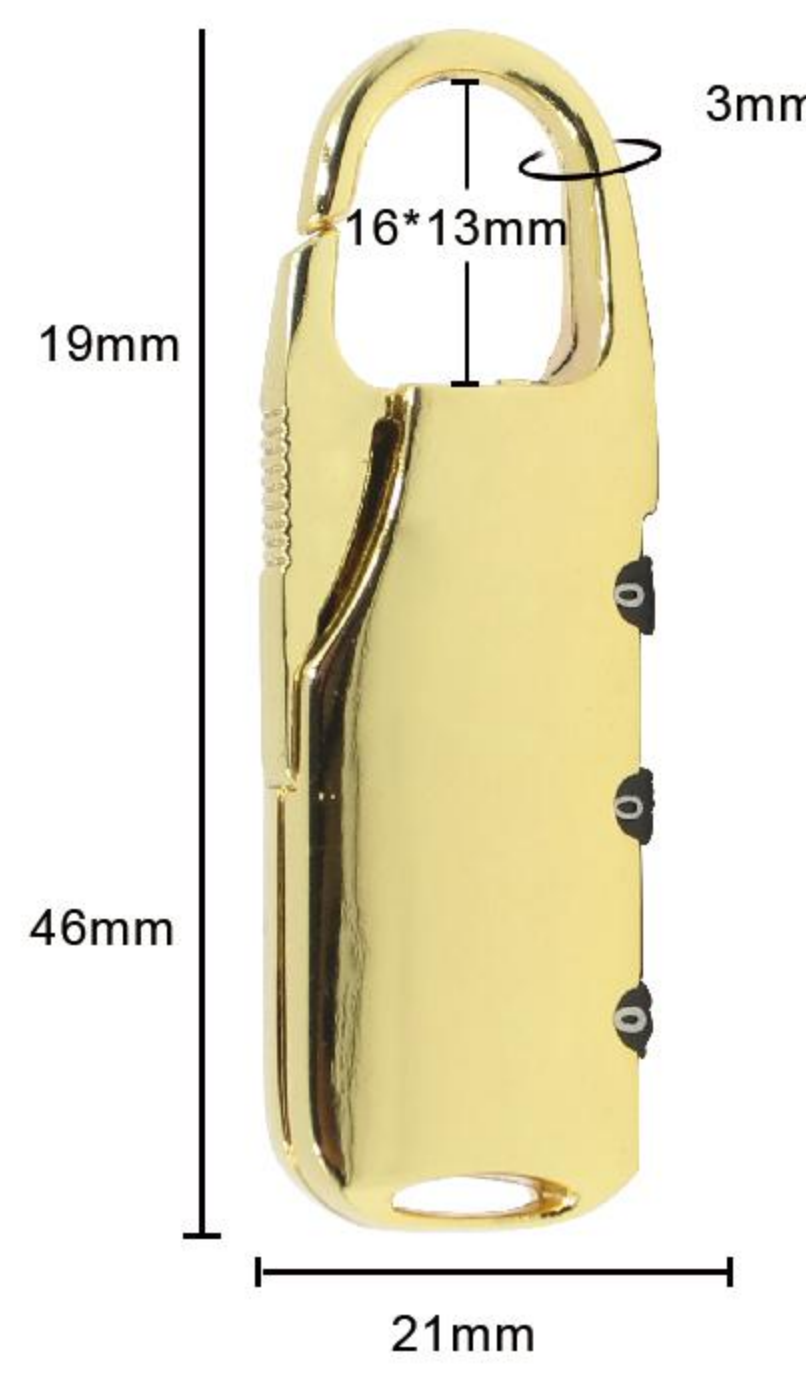

**Item:8064A**  
 Size: 2.55\*0.82\*0.35in  
 Material: Zinc alloy  
 Weight: 29g



**Item:8065**  
 Size: 2.40\*0.94\*0.39in  
 Material: Zinc alloy  
 Weight: 17.5g

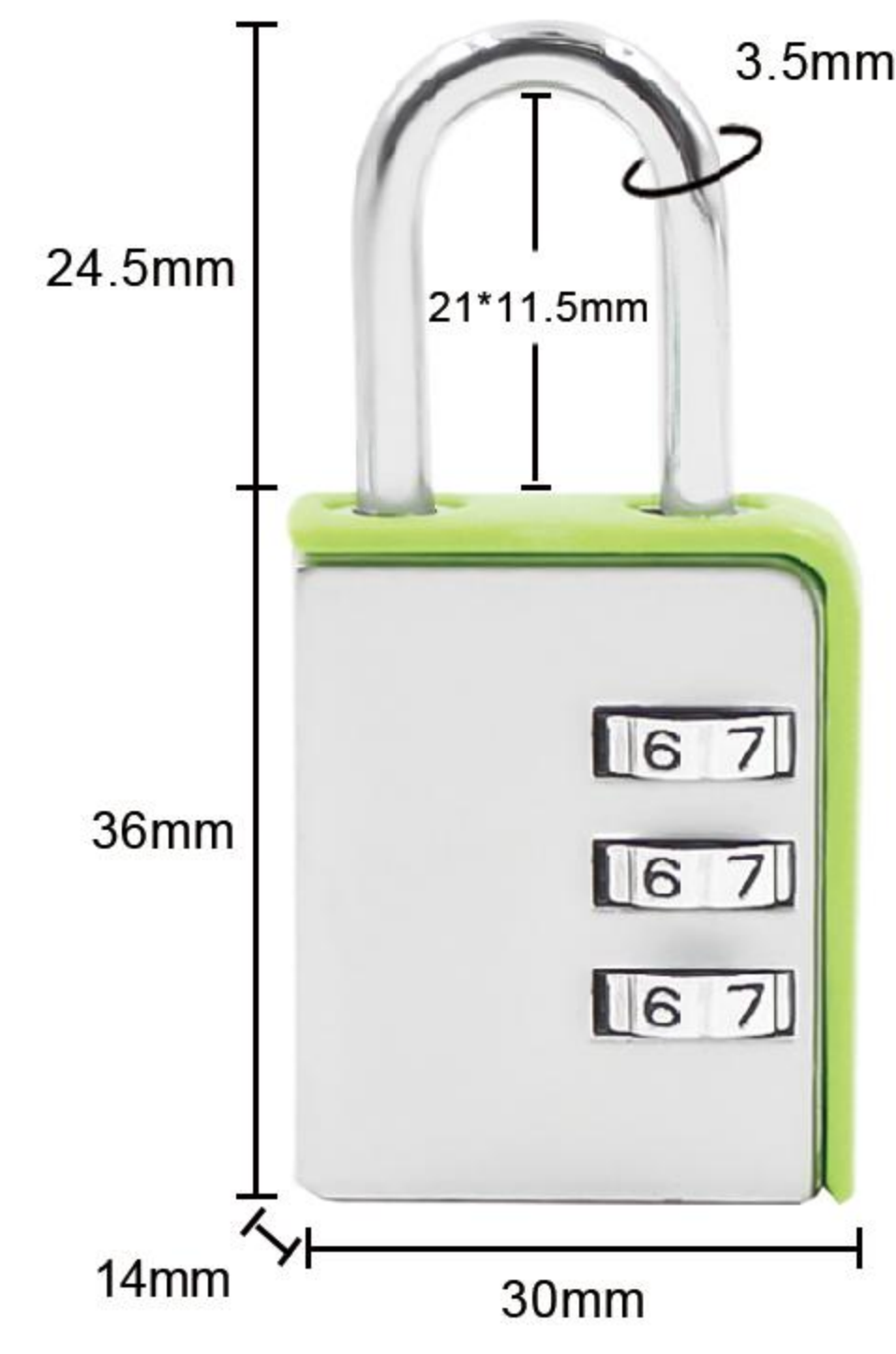

**Item:8072S**  
 Size: 2.38\*1.18\*0.55in  
 Material: Zinc alloy  
 Weight: 39g

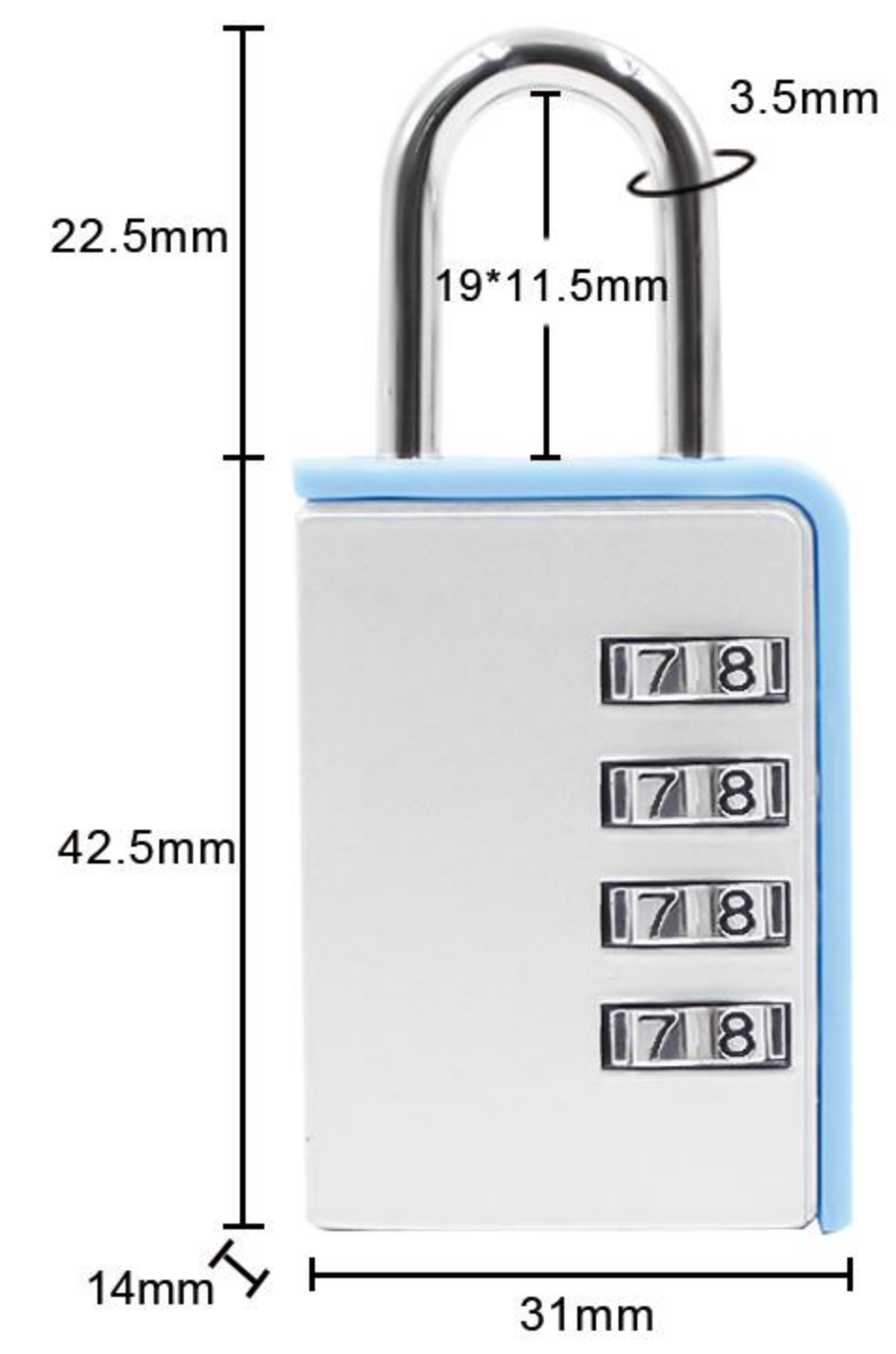

**Item:J-8072**  
 Size: 2.56\*1.22\*0.55in  
 Material: Zinc alloy  
 Weight: 46g

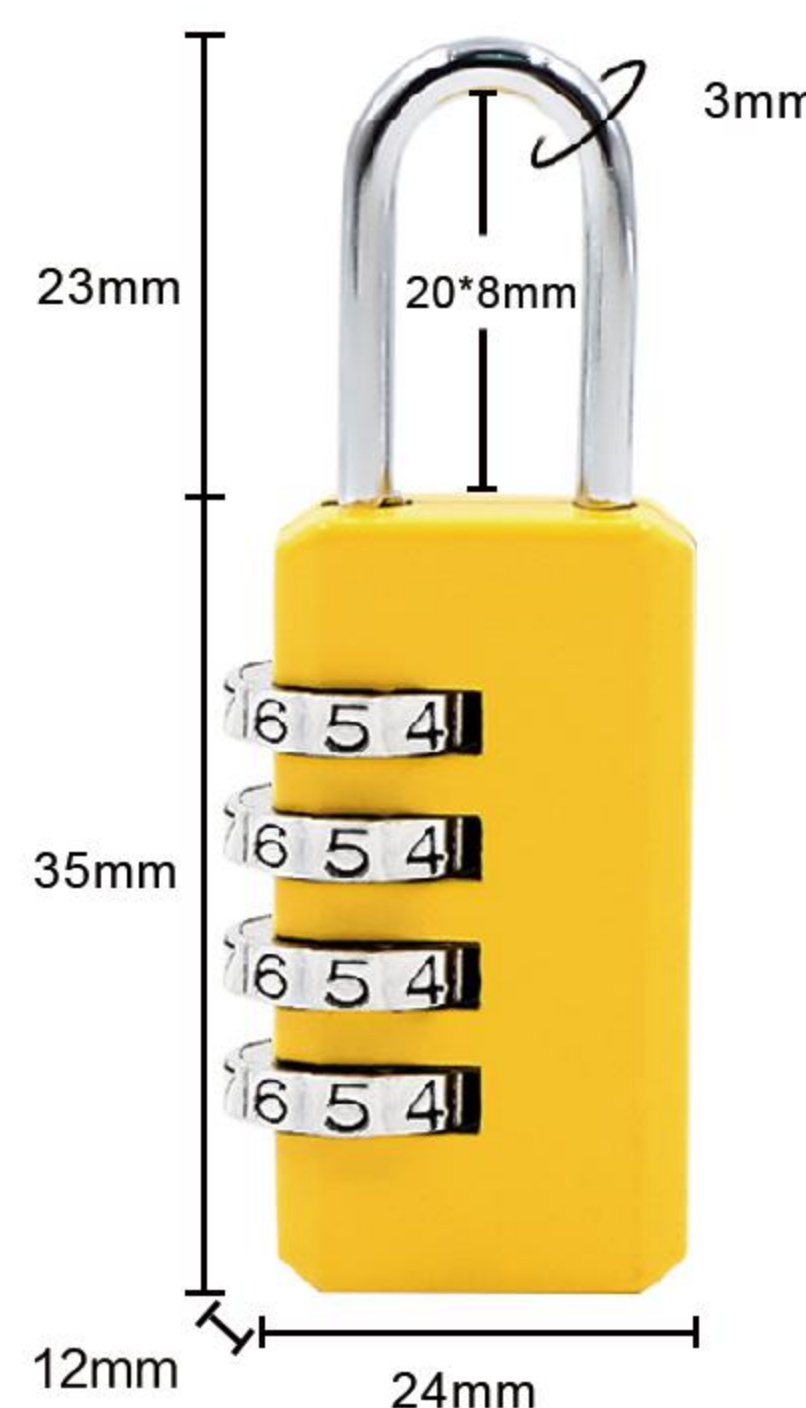

**Item:8066**  
 Size: 2.40\*0.94\*0.47in  
 Material: Zinc alloy  
 Weight: 24g

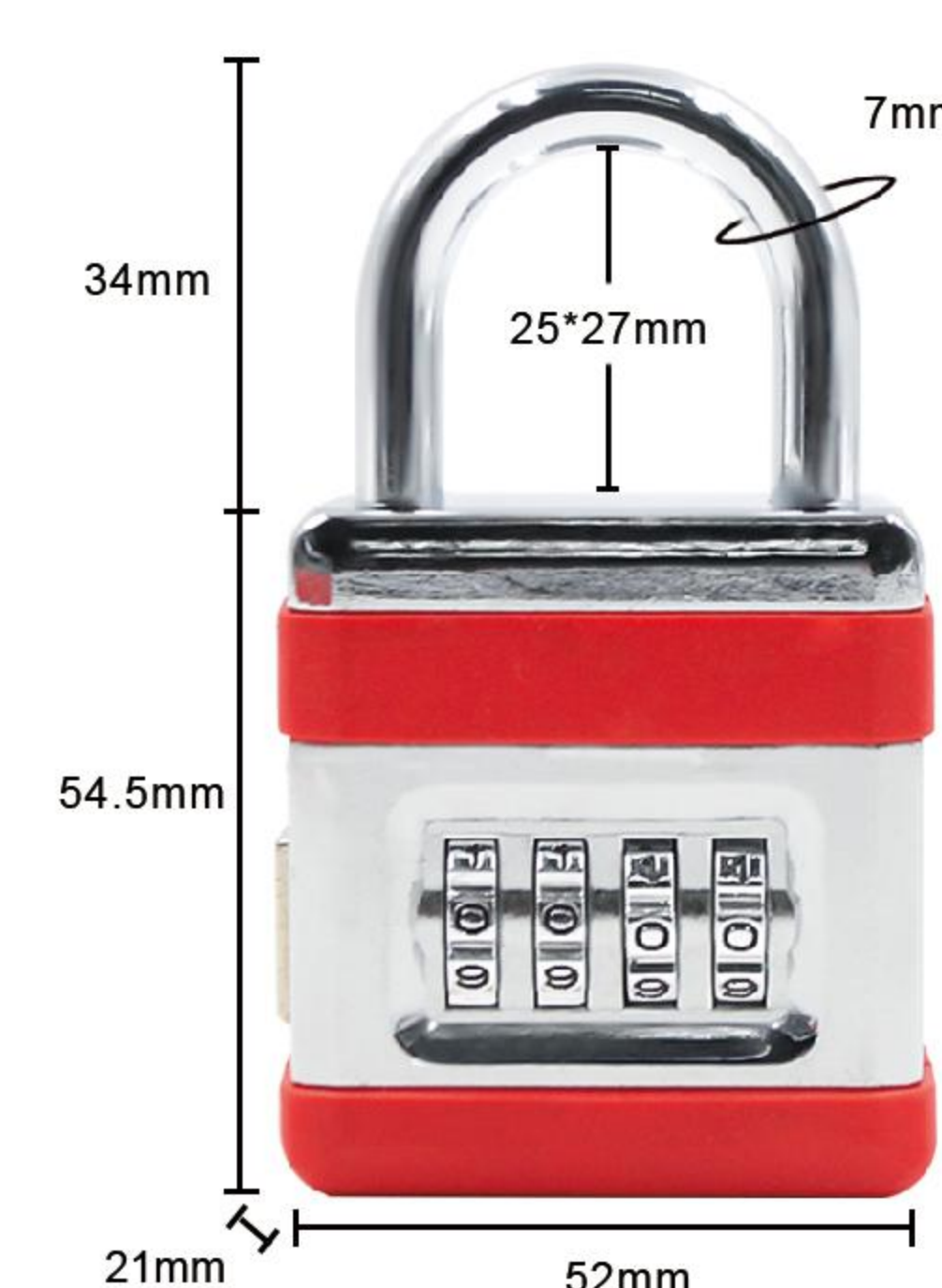

**Item:8067**  
 Size: 3.48\*2.05\*0.83in  
 Material: Zinc alloy  
 Weight: 207g

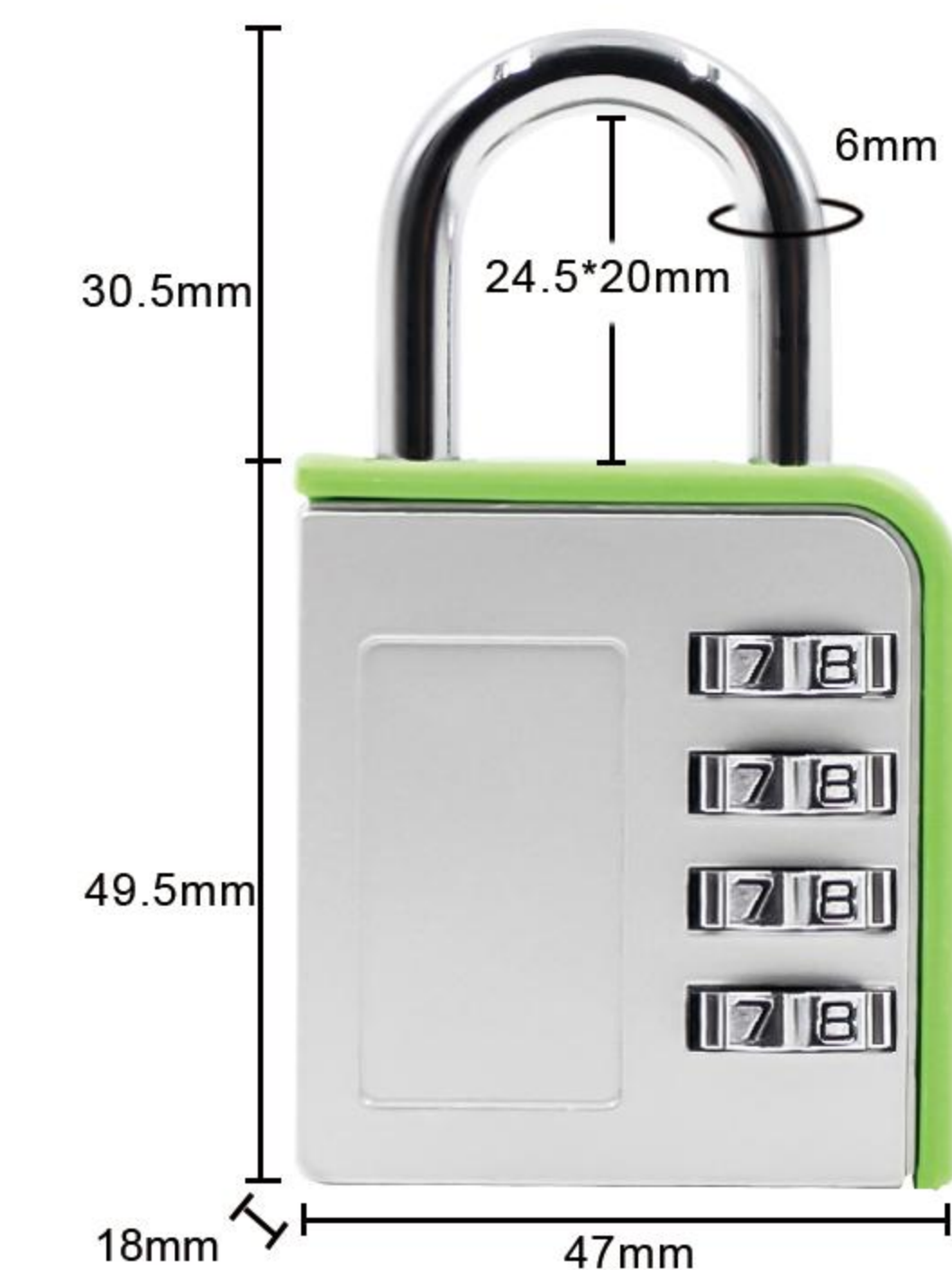

**Item:8072L**  
 Size: 3.15\*1.85\*0.71in  
 Material: Zinc alloy  
 Weight: 119g

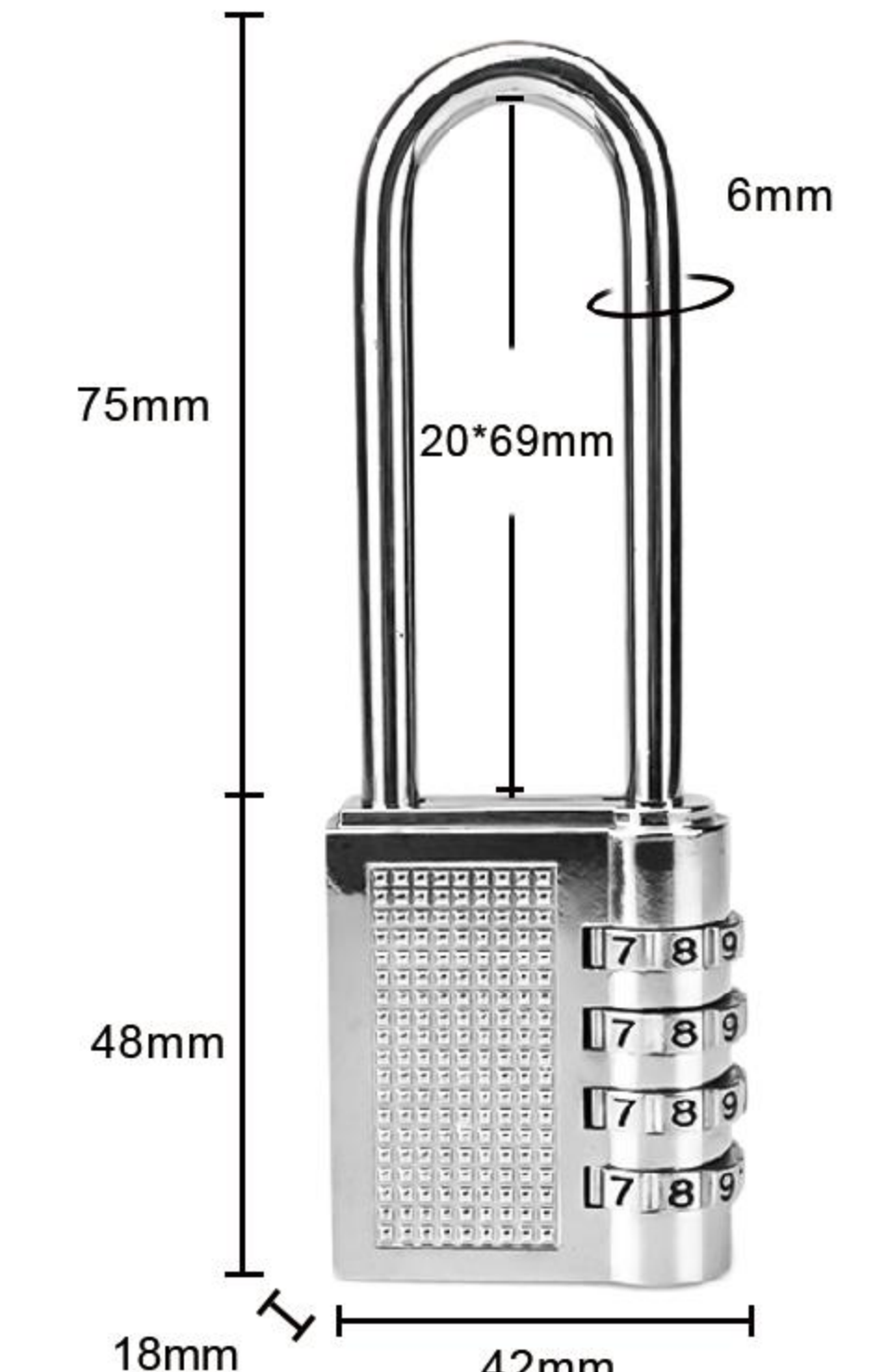

**Item:8073**  
 Size: 4.84\*1.65\*0.71in  
 Material: Zinc alloy  
 Weight: 124g



**Item:8068**  
 Size: 3.39\*1.14\*0.75in  
 Material: Zinc alloy  
 Weight: 29g

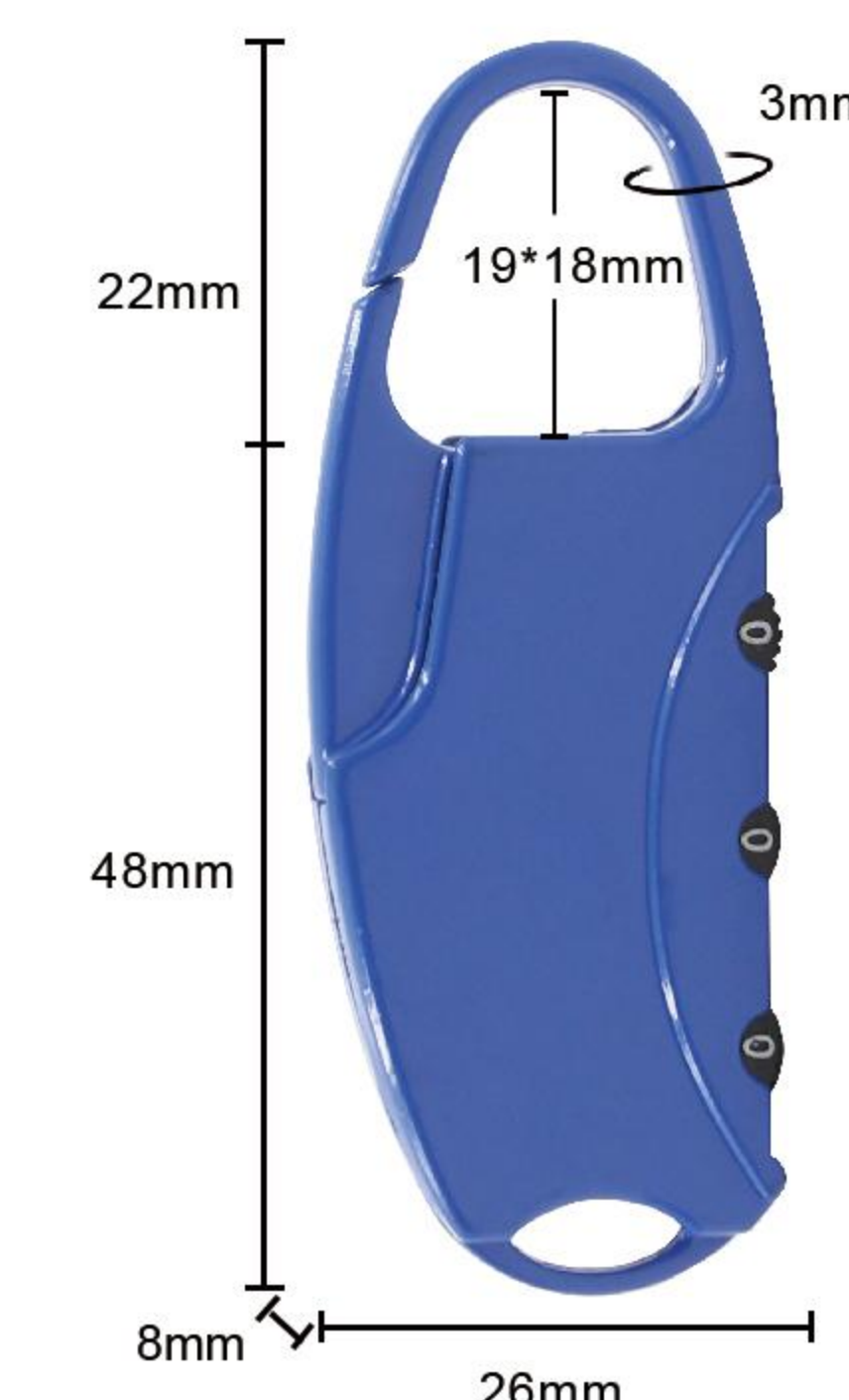

**Item:8069**  
 Size: 2.75\*1.02\*0.31in  
 Material: Zinc alloy  
 Weight: 27g



**Item:8074**  
 Size: 3.39\*2.05\*0.71in  
 Material: Zinc alloy  
 Weight: 152g

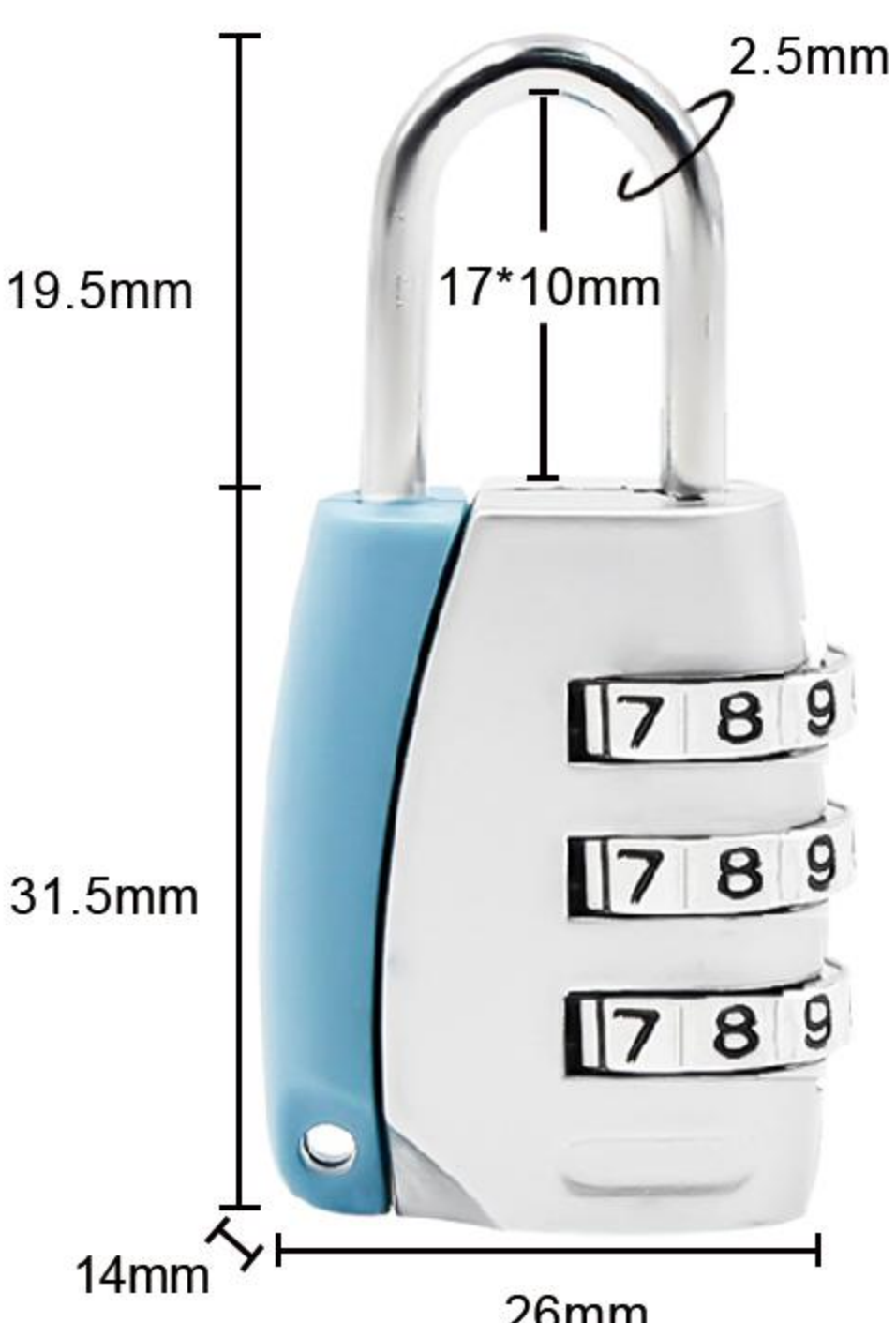

**Item:8075**  
 Size: 2.00\*1.02\*0.55in  
 Material: Zinc alloy  
 Weight: 28.4g



**Item:8075A**

Size: 2.36\*1.34\*0.59in  
Material: Zinc alloy  
Weight: 54.5g



**Item:8075B**

Size: 2.52\*1.30\*0.55in  
Material: Zinc alloy  
Weight: 43g

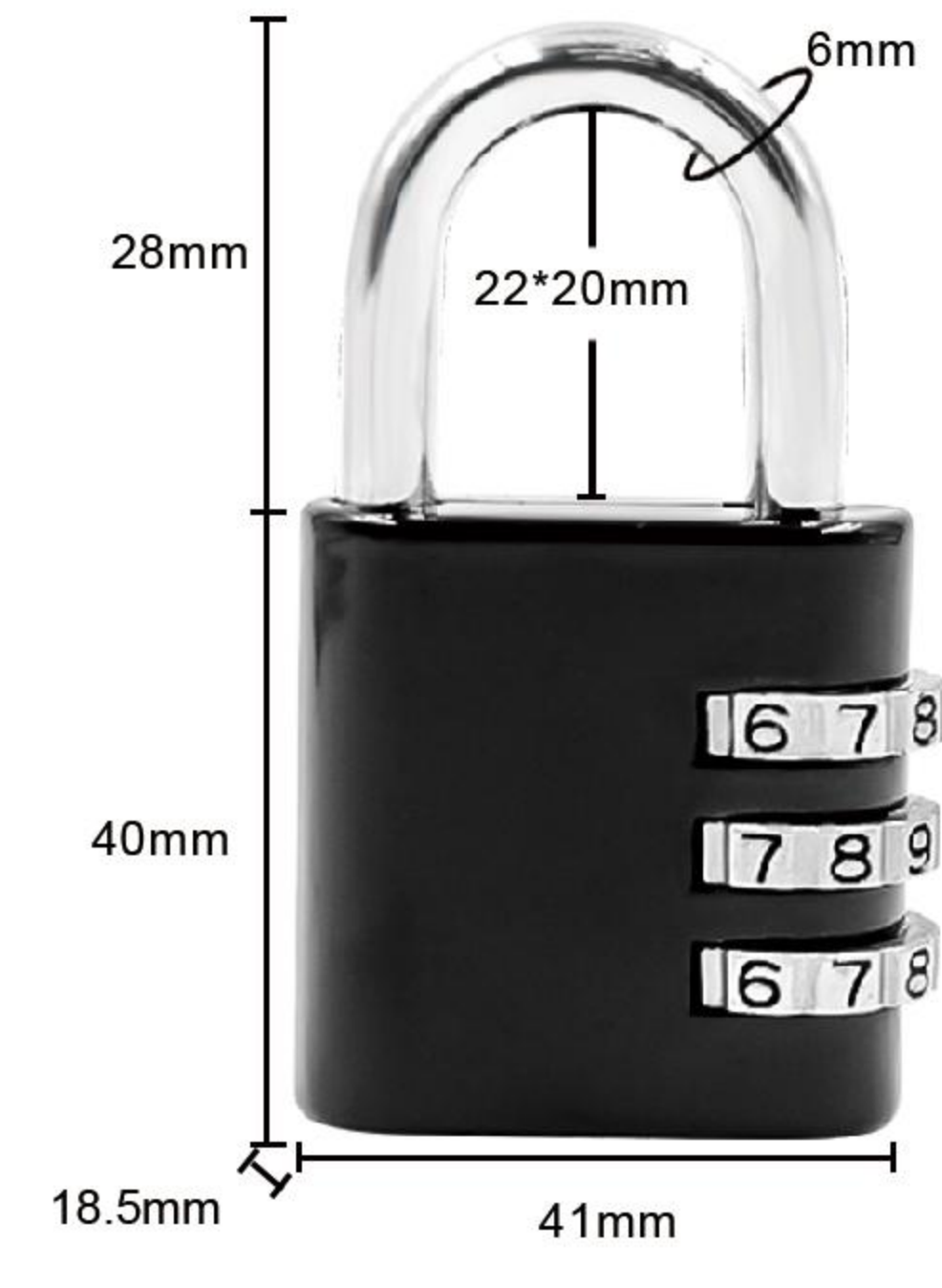

**Item:8082**

Size: 2.68\*1.61\*0.73in  
Material: Zinc alloy  
Weight: 87.2g

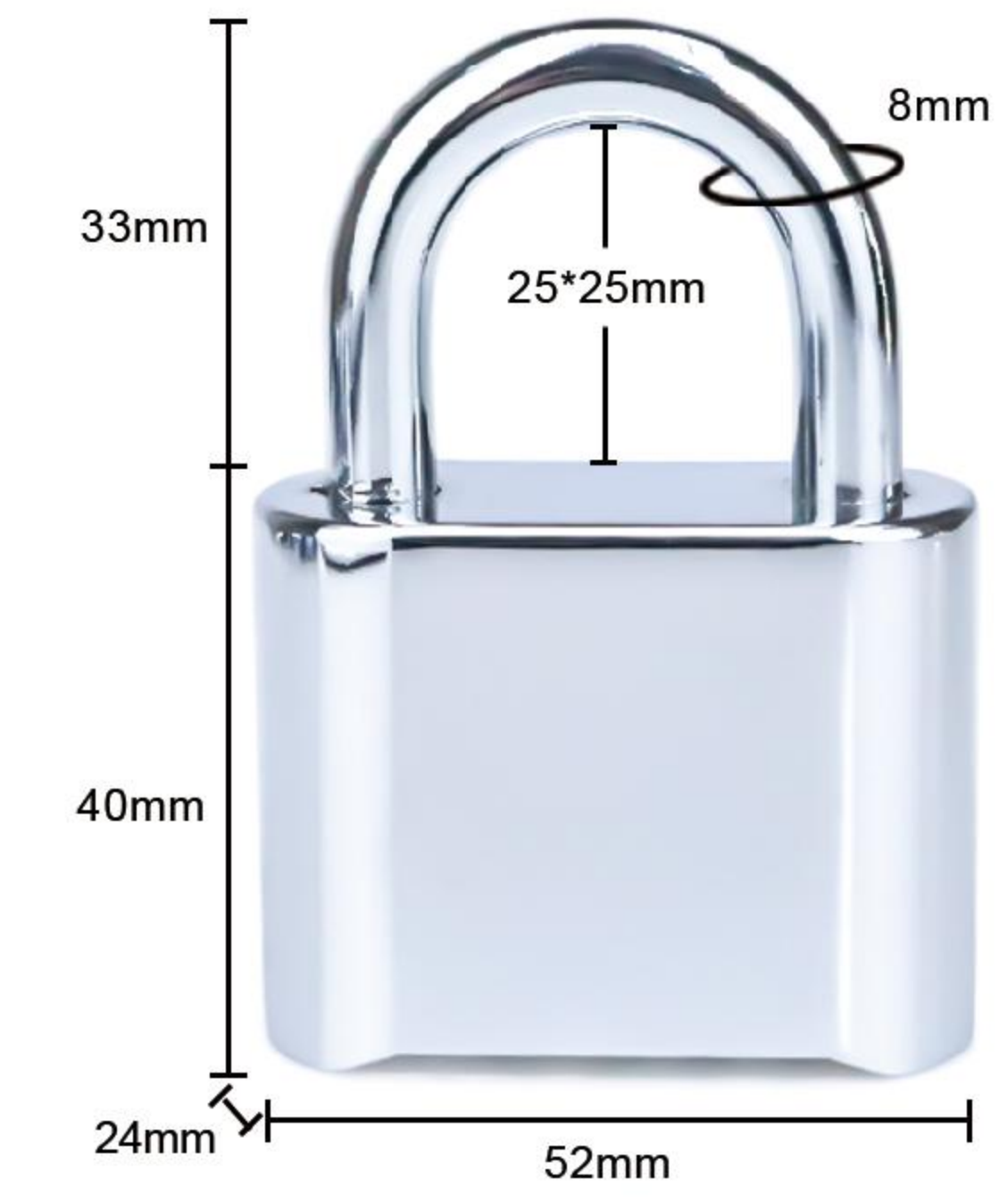

**Item:8083**

Size: 2.87\*2.05\*0.94in  
Material: Zinc alloy  
Weight: 232g



**Item:8075C**

Size: 3.03\*1.22\*0.71in  
Material: Zinc alloy  
Weight: 100g

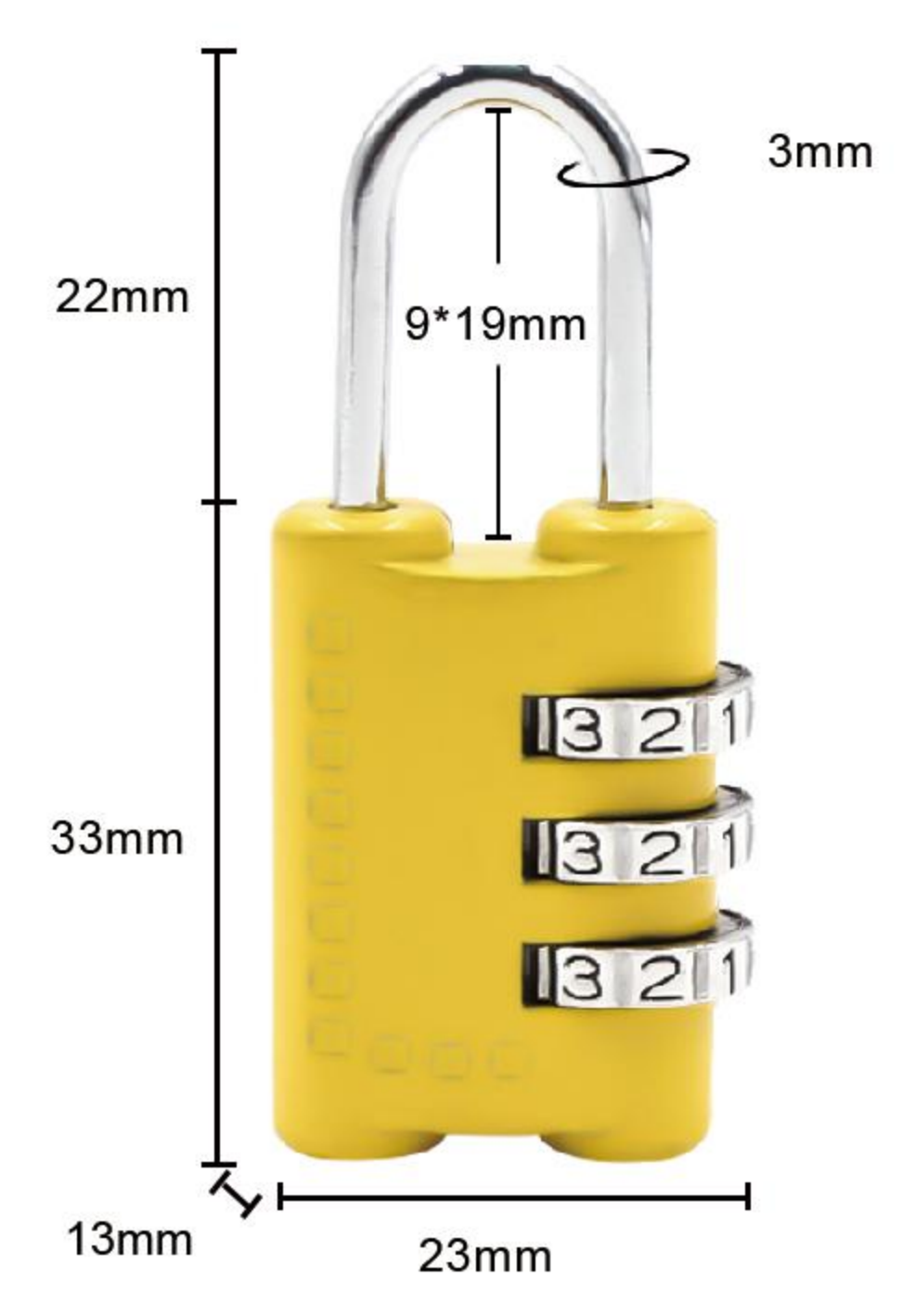

**Item:8077**

Size: 2.16\*0.90\*0.51in  
Material: Zinc alloy  
Weight: 21g

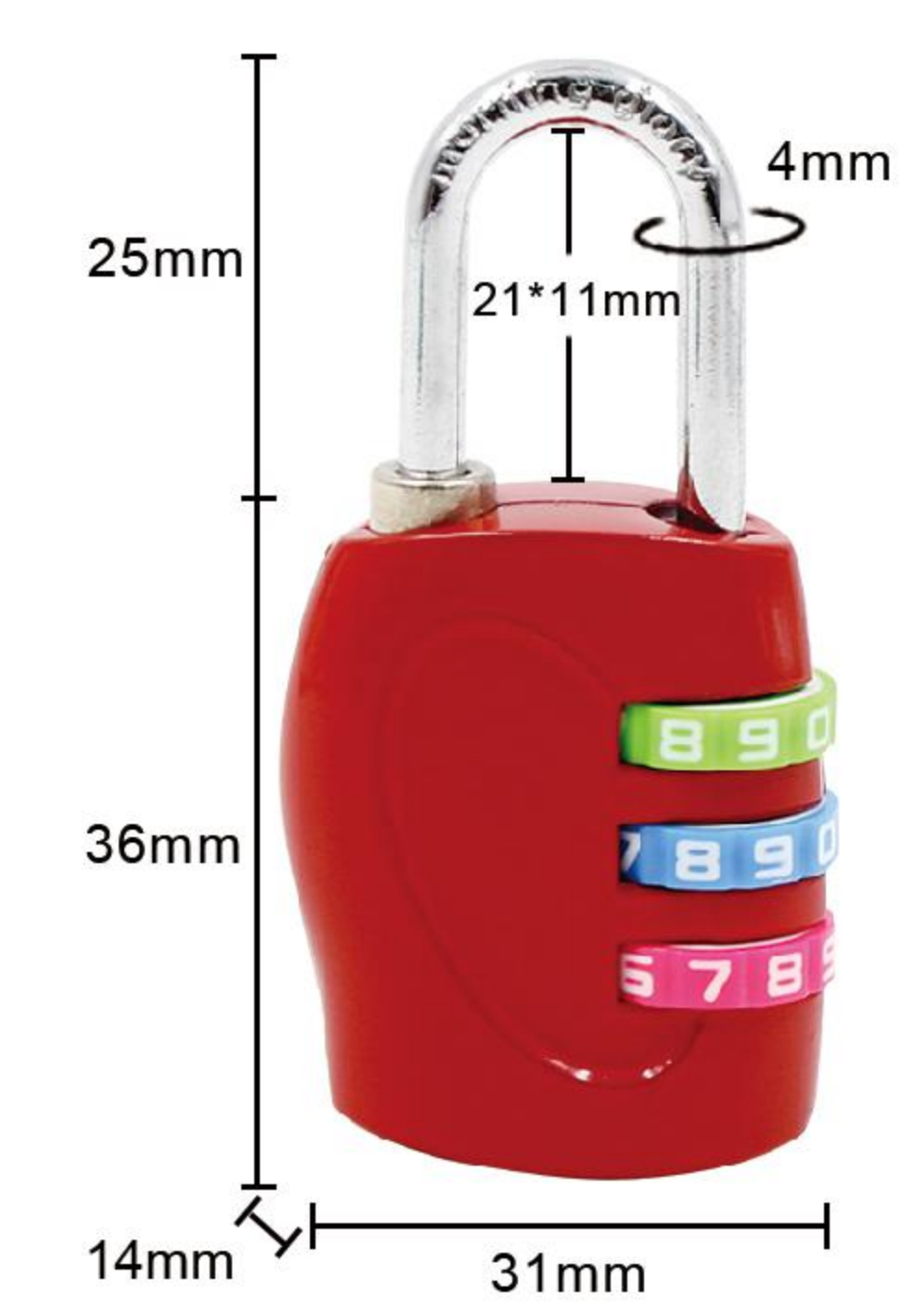

**Item:8088**

Size: 2.40\*1.22\*0.55in  
Material: Zinc alloy  
Weight: 46g

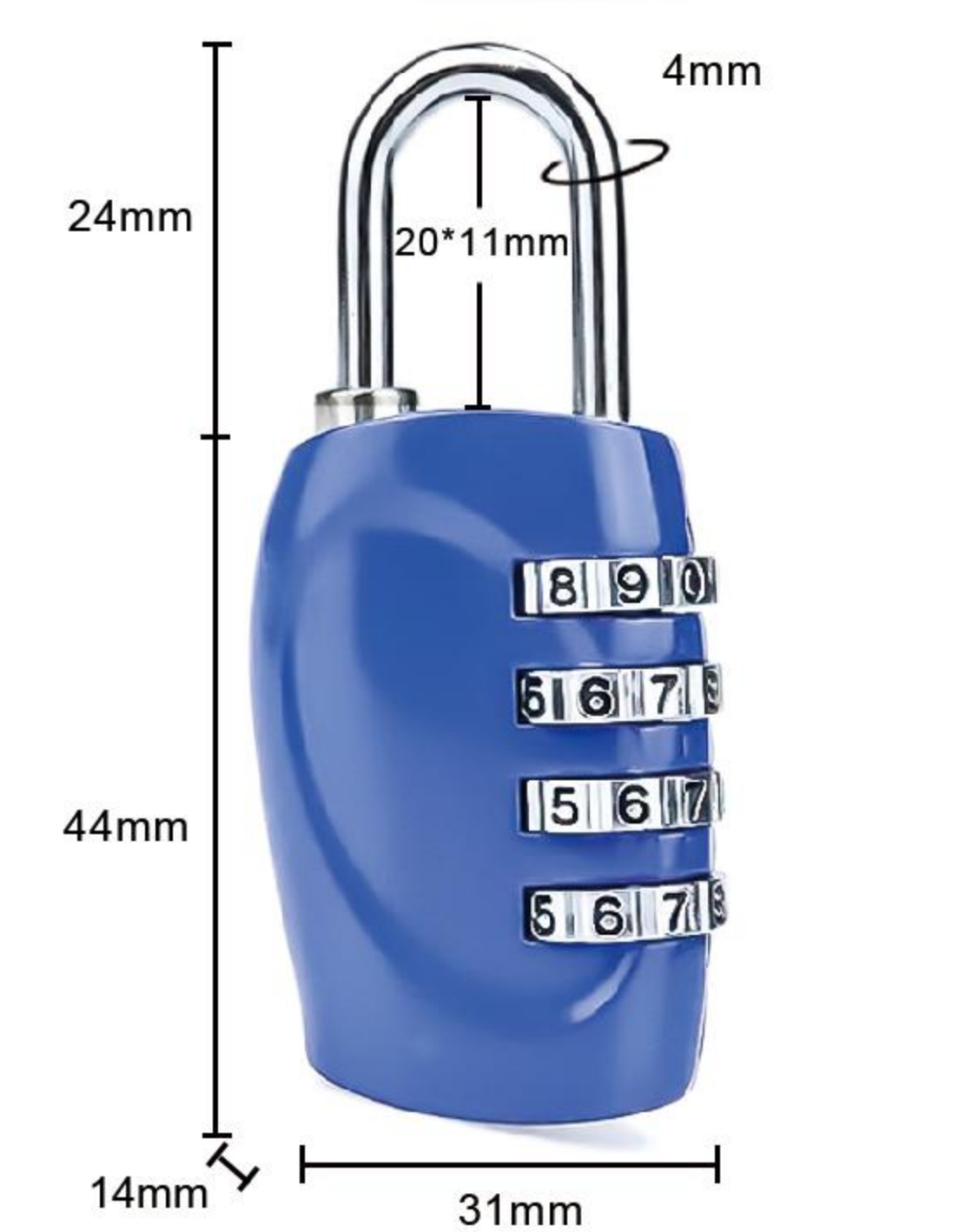

**Item:8088A**

Size: 2.68\*1.22\*0.55in  
Material: Zinc alloy  
Weight: 44.2g

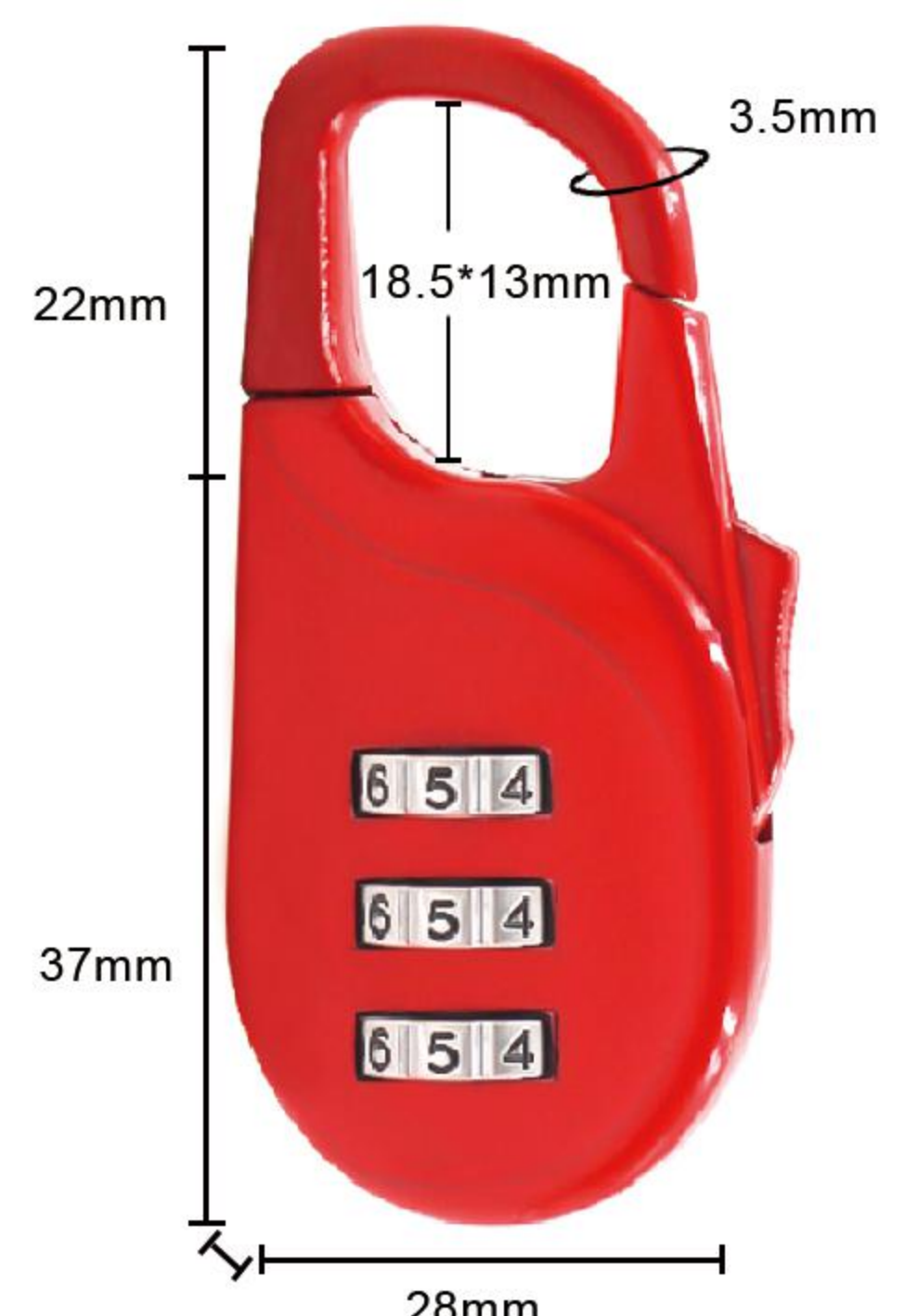

**Item:8079**

Size: 2.36\*1.10\*0.47in  
Material: Zinc alloy  
Weight: 28.1g



**Item:8080**

Size: 2.44\*0.98\*0.35in  
Material: Zinc alloy  
Weight: 29.6g

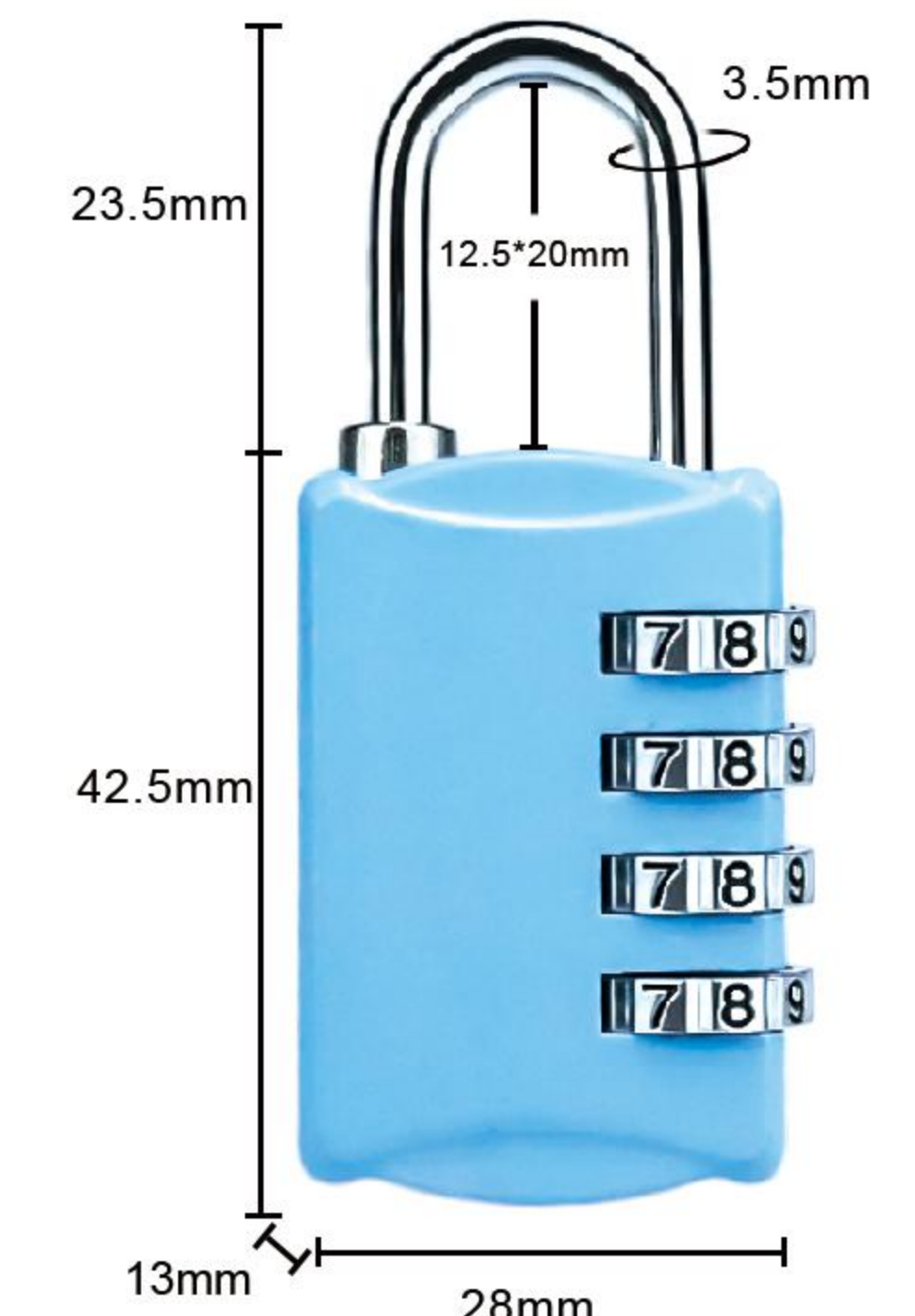

**Item:8089**

Size: 2.60\*0.94\*0.39in  
Material: Zinc alloy  
Weight: 17.5g



**Item:8090**

Size: 2.28\*1.18\*0.55in  
Material: Zinc alloy  
Weight: 37.9g



**Item:8080A**

Size: 2.40\*0.94\*0.39in  
Material: Zinc alloy  
Weight: 54.2g



**Item:8081**

Size: 1.97\*1.41\*0.47in  
Material: Zinc alloy  
Weight: 32g

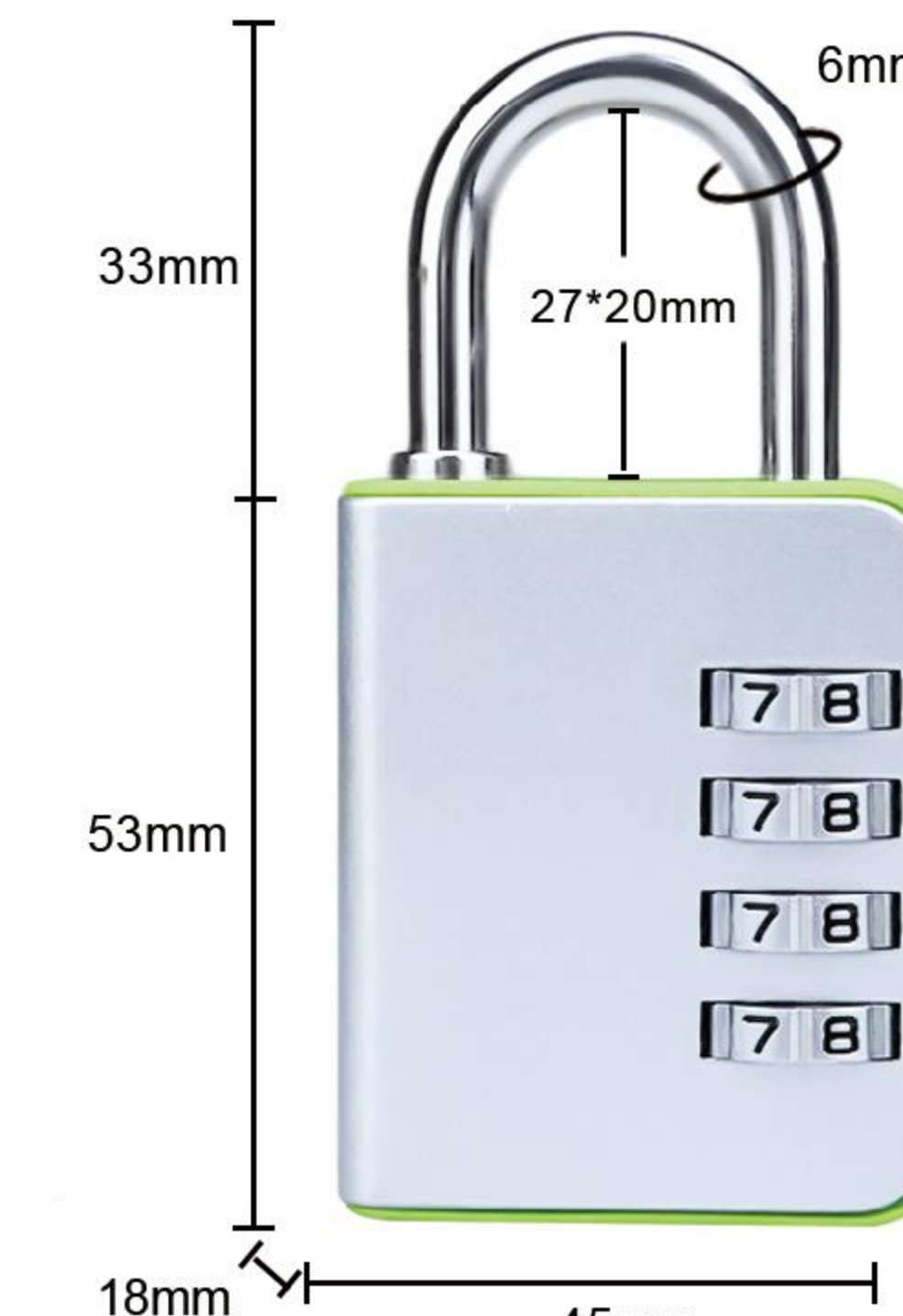

**Item:8091**

Size: 3.39\*1.77\*0.71in  
Material: Zinc alloy  
Weight: 129g

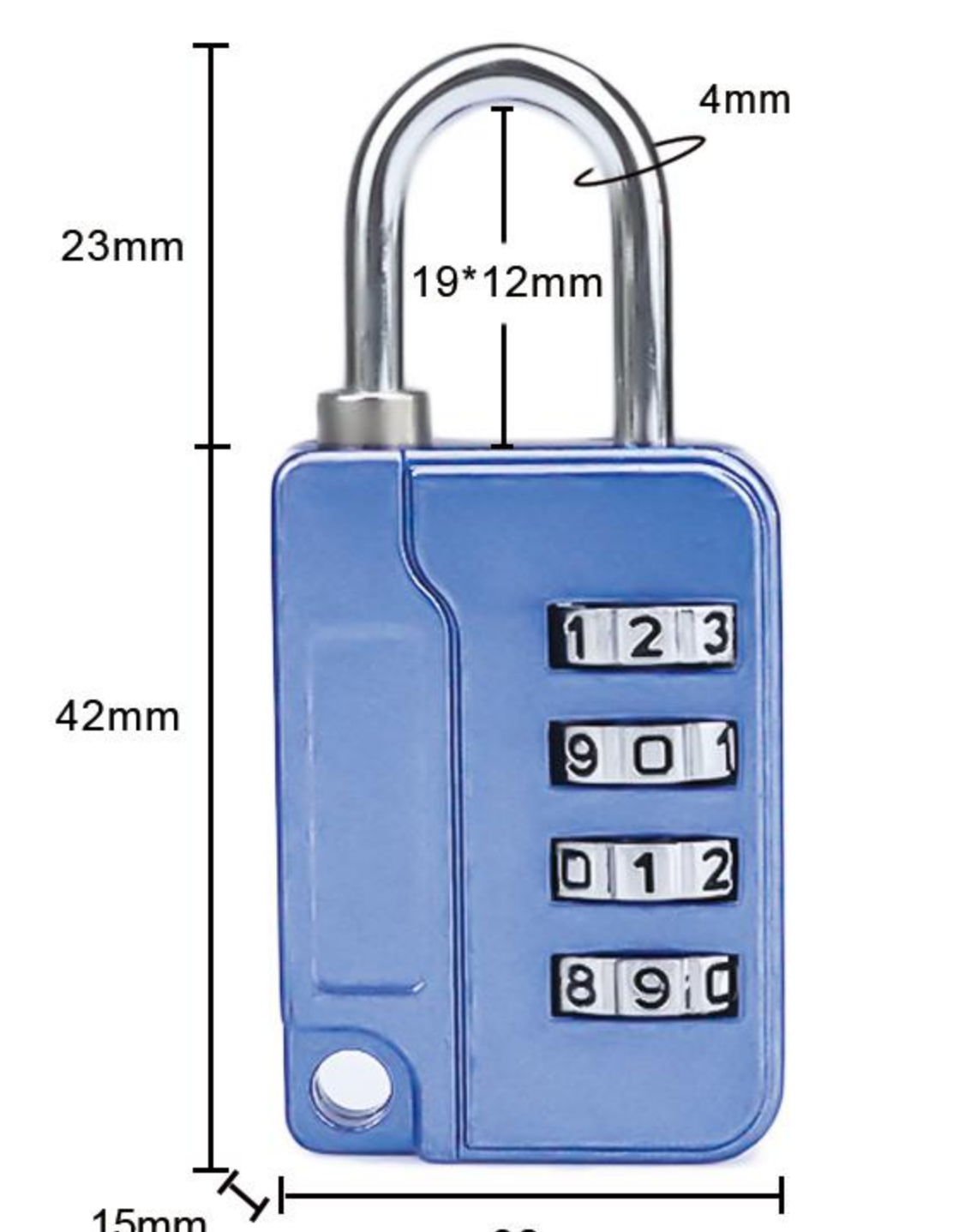

**Item:8092**

Size: 2.64\*1.18\*0.59in  
Material: Zinc alloy  
Weight: 51.6g

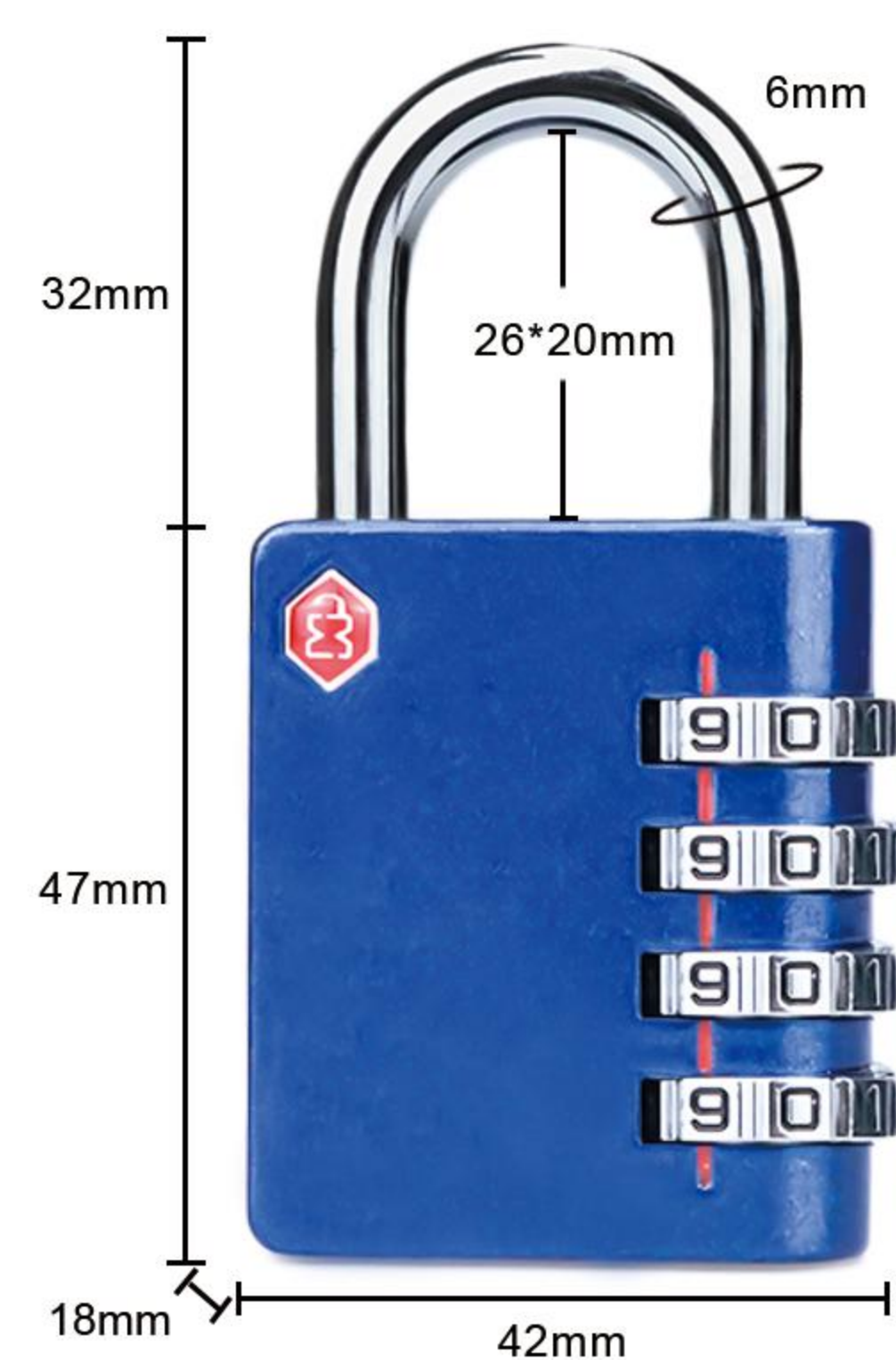

**Item:8093**  
Size: 3.11\*1.65\*0.71in  
Material: Zinc alloy  
Weight: 115g



**Item:8801**  
Size: 1.97\*1.73\*0.47in  
Material: Zinc alloy  
Weight: 48g



**Item:8802**  
Size: 2.48\*1.18\*0.55in  
Material: Zinc alloy  
Weight: 48.2g

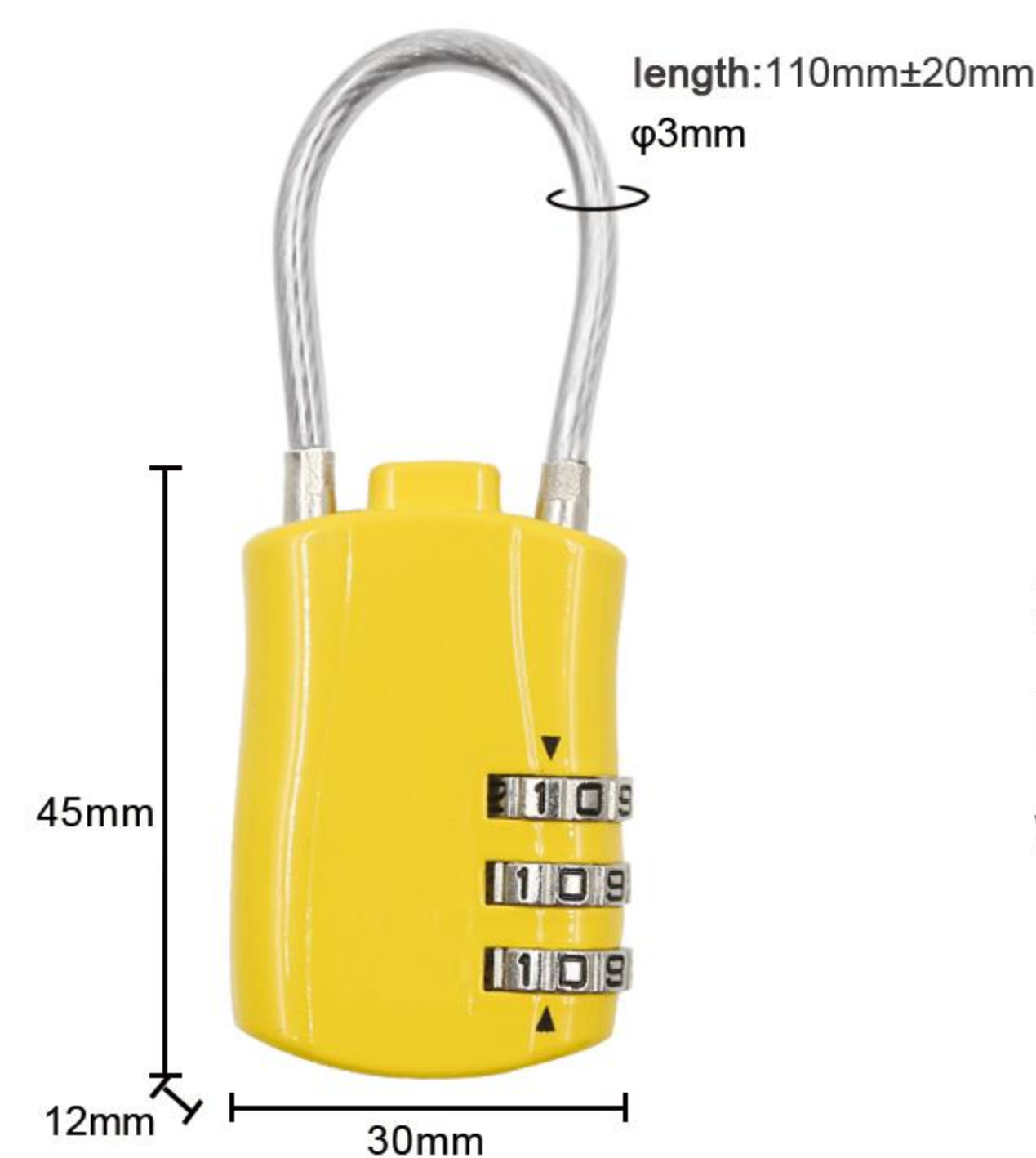

**Item:8803**  
Size: 1.77\*1.18\*0.47in  
Material: Zinc alloy  
Weight: 45.2g



**Item:8804**  
Size: 2.32\*1.93\*0.47in  
Material: Zinc alloy  
Weight: 50g

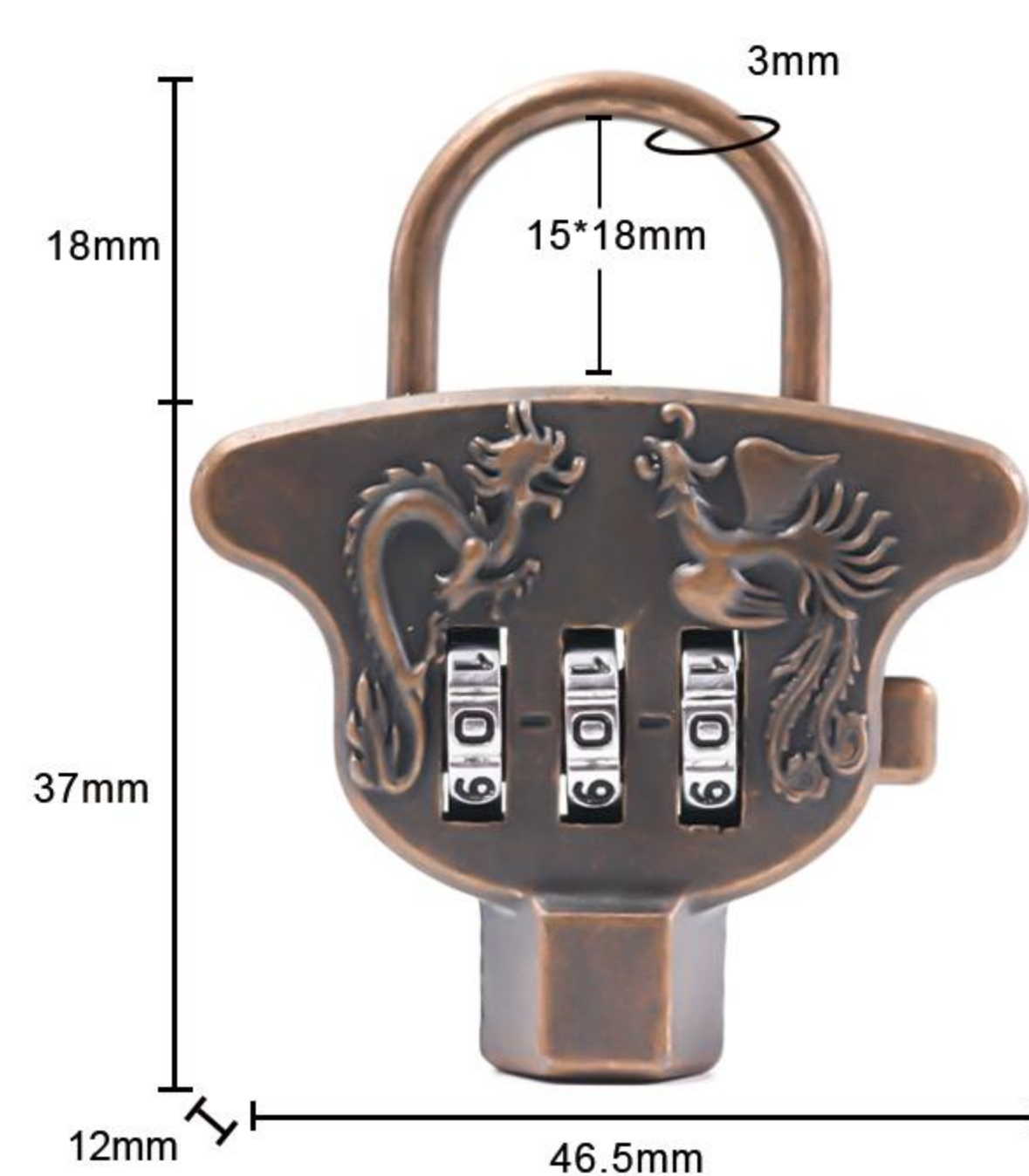

**Item:8805**  
Size: 2.40\*0.94\*0.39in  
Material: Zinc alloy  
Weight: 30g

重设密码操作方式请查阅说明书（一）、说明书（二）和说明书（三）

To reset password operation please refer to the Instruction 1、Instruction 2 and Instruction 3



适用场景：箱包/case 柜子/cabinet 大门/door 背包/bag 等

说明书（一）  
Instruction 1

该产品出厂前的原始密码为0-0-0-0 (0-0-0)，请按以下步骤设置您的个人密码：

- 1.工厂初始密码000 (0000)确保数字对准刻度线,拉起锁梁让锁处于开启状态
- 2.锁钩旋转180° (90°), 当锁钩尖头指向凹点时,用力按下锁钩至底。(如没按到底,易造成卡锁乱码)
- 3.旋转密码轮设置您的个人密码,完成后拉起锁钩。(如不能完全拉起,回到第一步重新设置)
- 4.拉起锁梁回到原位,切记要记住您刚才设置的密码。

This lock is preset at the factory to open at 0-0-0-0(0-0-0),please follow the steps below to set your own combination.

- 1.Begin the code 0000 (000) with the front tick mark and pull up the lock beam
- 2.Rotate 180° (90°) counterclockwise, lock the beam's convex beam against the recess and press the bottom firmly. (Not pressed in the end, it is easy to cause card lock error)
- 3.After pressing down, align the password you need with the scale and fully pull the lock beam. (If you do not completely pull up, go back to the initial password and set again)
- 4.After pulling the lock beam, turn the lock beam 180° (90°) back to its original position. (Please confirm the password again)

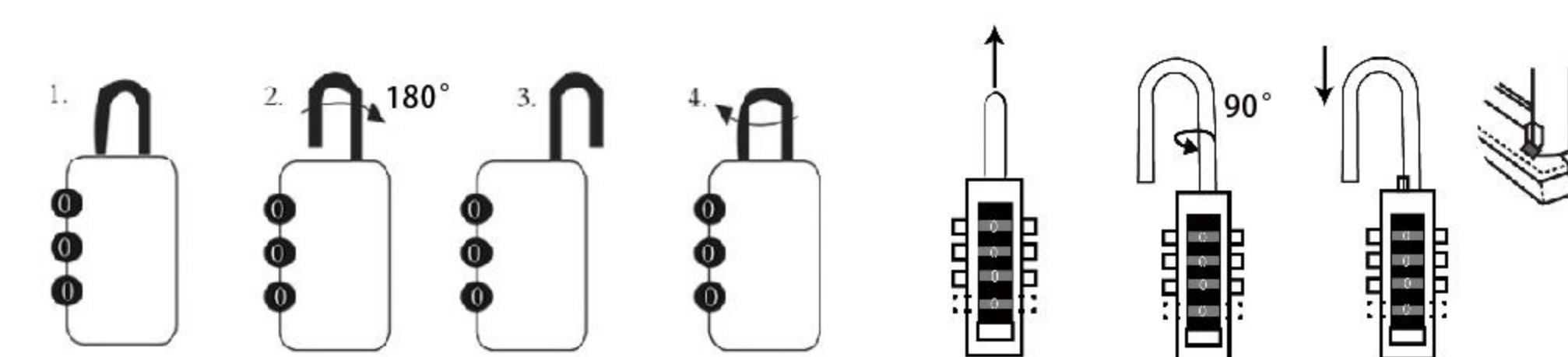

说明书（二）  
Instruction 2

该组合锁厂内设置的开启密码为0-0-0，您可以保留此设置，也可以以下列方式在拨盘上设置您自己的密码。

- 1.在锁打开之时，按住按钮，并保持不动直至第二项操作完成；
- 2.设定数轮至期望的密码组合，注意有一定的转动阻力，勿忘记您已设置好的密码组合；
- 3.设置好后可以将按钮松开，然后再次打开此按钮以作检验。

The defaulting cipher set in the factory is 0-0-0. You can either keep this setting or set your own cipher as follows:

- 1.Before opening the lock,push down button -along the arrow,keep still until the second operation is done.
- 2.Set No.wheels to the expected password composition.Please note there is a certain rotary resistance.Never forget the password you set by yourself.
- 3.Now loosen button and pull it again to check.

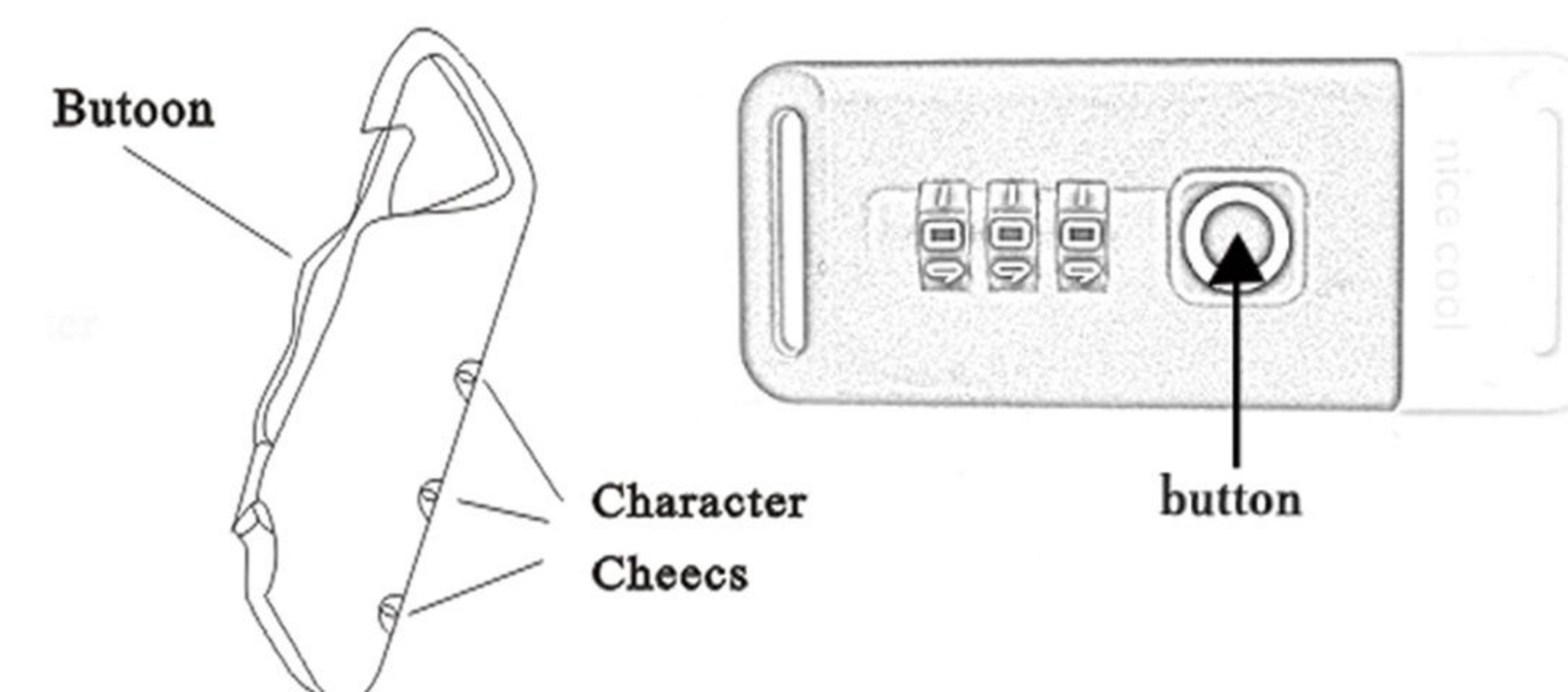

说明书（三）  
Instruction 3

该组合锁厂内设置的开启密码为0-0-0，您可以保留此设置或设定您自己的密码，其设定方法如下：

- 1.用尖锐物品顶住侧方或下方位置的调码套，保持不动
- 2.同时转动密码轮，将自己所想的数字对准中轴线即可改密
- 3.将尖锐物品松开调码套即可完成改密，切记要记住您设置的密码。

The lock is set at the manufacturer to open at 0-0-0.You can keep it as your own combination,or set a new one as following steps:

- 1.Using the sharp object against the adjusting sleeve in the side or bottom position and hold on
2. At the same time,turn the password wheel and align your personal combinations with the indication line
- 3.Release the button and rotate the dials so that your three secret numbers can't be seen.

